



Sensor Length Specification Form

Part # CDS-B1F47
(old part # 123280)

Customer: _____ Sales Order #: _____

Due Date: _____ PO # _____

- Insert your required sensor length in the box below.
- Sign this form and fax back to INFICON at 315-434-2552, or e-mail to: _____

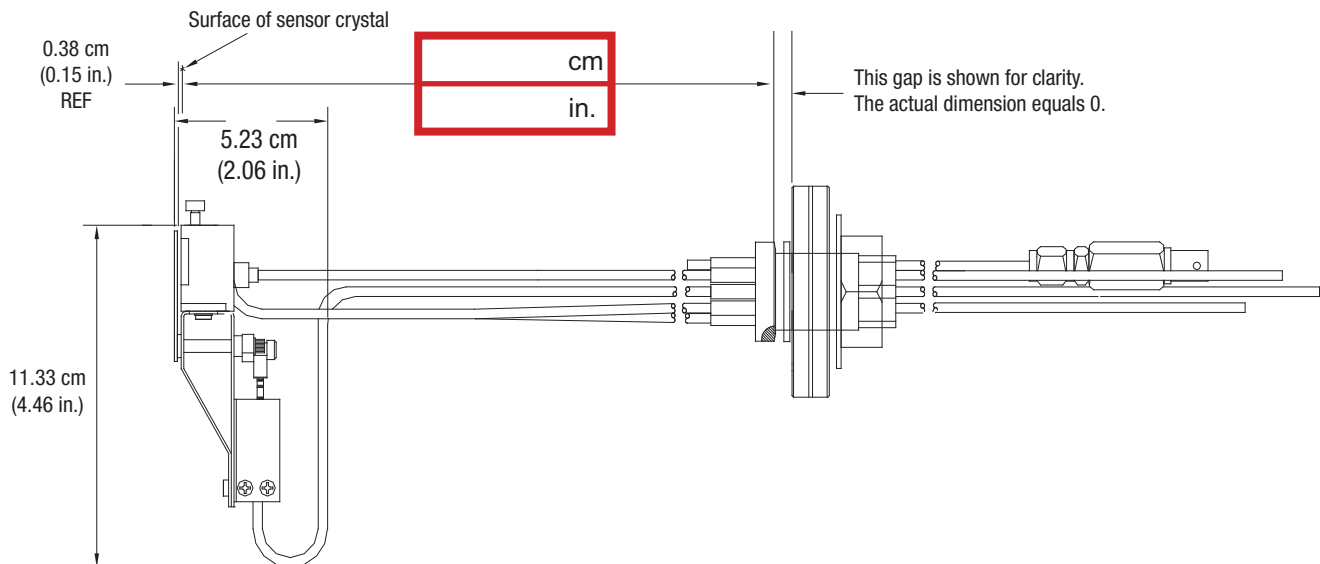

Standard sensor length can be from 10 to 66 cm (4 to 26 in.)

Other lengths may be available on request. These will be subject to additional cost and lead-time. Contact factory for availability.

Note: Lengths have a tolerance of +/- 6.35 mm (0.25 in.)

Typical lead time is approximately three weeks from receipt of completed drawing for standard sensor length. Contact INFICON for a more accurate lead time estimate.

IMPORTANT! The above mentioned lead-time does not start until INFICON has received this completed sensor length specification form.

PLEASE NOTE: This is a special sensor and cannot be restocked or cancelled.

Customer Signature: _____