

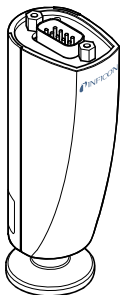

Capacitance Diaphragm Gauge

Porter™ CDG020D





Operating Manual
Incl. EC Declaration of Conformity

Product Identification

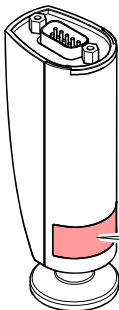
In all communications with INFICON, please specify the information given on the product nameplate. For convenient reference copy that information into the space provided below.



INFICON AG, LI-9496 Balzers		
Model:		
PN:		
SN:		
..... V W	 <small>3103457</small>

Validity

This document applies to products of the CDG020D series.

Part numbers of standard products are indicated below. OEM products have other part numbers and different parameter settings (e.g. customized measurement range) as defined in the corresponding ordering information.

3CAx-xxx-0x00

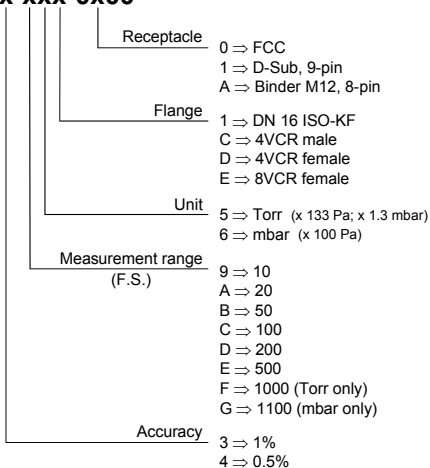

The part number (PN) can be taken from the product nameplate. If not indicated otherwise in the legends, the illustrations in this document correspond to gauges with D-Sub receptacle and the DN 16 ISO-KF vacuum connection. They apply to other gauges by analogy.

We reserve the right to make technical changes without prior notice.

All dimensions in mm.

Intended Use

The Capacitance Diaphragm Gauges of the CDG020D series are intended for absolute pressure measurement of gases in their respective pressure ranges (→ 3).

The gauges can be operated in connection with an INFICON Vacuum Gauge Controller (VGC series) or another appropriate measuring unit.

Function

The Capacitance Diaphragm Gauge consists of a capacitive sensor element made of aluminum oxide ceramics and electronics which convert the capacitance into a DC voltage output signal.

The output signal is linear to the measured pressure and independent of the gas type.

Trademarks

Porter™ INFICON GmbH
VCR® Swagelok Marketing Co.



Patents

EP 1070239 B1, 1040333 B1

US 6528008 B1, 6591687 B1, 7107855 B2, 7140085 B2,
7536915 B2

Contents

Product Identification	2
Validity	3
Intended Use	4
Function	4
Trademarks	4
Patents	4
1 Safety	6
1.1 Symbols Used	6
1.2 Personnel Qualifications	6
1.3 General Safety Instructions	7
1.4 Liability and Warranty	7
2 Technical Data	8
3 Installation	13
3.1 Vacuum Connection	13
3.2 Power Connection	16
3.2.1 FCC68, 8-pin Connector	17
3.2.2 D-Sub, 9-pin Connector	18
3.2.3 Binder M12, 8-pin	19
4 Operation	20
4.2 Zeroing the Gauge	20
4.2.1 Zero Adjustment	20
5 Deinstallation	22
6 Maintenance, Repair	23
7 Returning the Product	24
8 Disposal	25
Further Information	26
ETL Certification	26
EC Declaration of Conformity	27

For cross-references within this document, the symbol (→  XY) is used, for cross-references to further documents, listed under "Further Information", the symbol (→  [Z]).

1 Safety

1.1 Symbols Used



DANGER

Information on preventing any kind of physical injury.



WARNING

Information on preventing extensive equipment and environmental damage.



Caution

Information on correct handling or use. Disregard can lead to malfunctions or minor equipment damage.



Notice

1.2 Personnel Qualifications



Skilled personnel

All work described in this document may only be carried out by persons who have suitable technical training and the necessary experience or who have been instructed by the end-user of the product.

1.3 General Safety Instructions

- Adhere to the applicable regulations and take the necessary precautions for the process media used.
Consider possible reactions with the product materials.
- Adhere to the applicable regulations and take the necessary precautions for all work you are going to do and consider the safety instructions in this document.
- Before beginning to work, find out whether any vacuum components are contaminated. Adhere to the relevant regulations and take the necessary precautions when handling contaminated parts.

Communicate the safety instructions to all other users.

1.4 Liability and Warranty

INFICON assumes no liability and the warranty becomes null and void if the end-user or third parties

- disregard the information in this document
- use the product in a non-conforming manner
- make any kind of interventions (modifications, alterations etc.) on the product
- use the product with accessories not listed in the product documentation.

The end-user assumes the responsibility in conjunction with the process media used.

Gauge failures due to contamination or wear and tear are not covered by the warranty.

2 Technical Data

Measurement range	→ "Validity"
Accuracy ¹⁾	
3CA3-xxx-xxxx	≤1% of reading
3CA4-xxx-xxxx	≤0.5% of reading
Temperature effect on zero	0.02% F.S./ °C
Temperature effect on span	0.02% of reading/ °C
Resolution	0.05% F.S.
Gas type dependence	none
<hr/>	
Output signal analog (measuring signal)	
Voltage range	-0.2 ... +10.24 V
Measuring range	0 ... +10 V
Relationship voltage-pressure	linear
Output impedance	10 Ω (short-circuit proof)
Loaded impedance	>10 kΩ
Response time	100 ms
<hr/>	
Gauge identification	Resistance 13.2 kΩ refer- enced to supply common
<hr/>	

¹⁾ Non-linearity, hysteresis, repeatability in the calibrated range at 25 °C ambient operating temperature without temperature effects after operation of 2 h.

Supply

DANGER

The gauge may only be connected to power supplies, instruments or control devices that conform to the requirements of a grounded protective extra-low voltage (SELV) and limited power source (LPS), Class 2. The connection to the gauge has to be fused ²⁾.

Supply voltage at the gauge	+13 ... +32 VDC
ripple	Class 2 / LPS ≤50 mV _{pp}
Current consumption	<20 mA
Power consumption	≤0.3 W
Fuse required ²⁾	1 AT (slow), automatic reset (Polyfuse)

The gauge is protected against reverse polarity of the supply voltage.

Electrical connection	
3CAx-xxx-0xxx	FCC68/RJ45, 8-pin, socket
3CAx-xxx-1xxx	D-Sub, 9-pin, male
3CAx-xxx-Axxx	Binder M12, 8-pin, male
Sensor cable	
3CAx-xxx-0xxx	8-pin plus shielding
3CAx-xxx-1xxx	9-pin plus shielding
3CAx-xxx-Axxx	8-pin plus shielding
Cable length	≤100 m (0.14 mm ² conductor)

For longer cables, larger conductor cross-sections are required.

Grounding concept	
Vacuum flange - signal common	→ "Power Connection"
Supply common - signal common	conducted separately; for differential measurement (10 Ω)

²⁾ INFICON controllers fulfill this requirement.

Materials exposed to vacuum	
Flange, tube	stainless steel AISI 316L
Sensor, feedthrough	ceramics ($\text{Al}_2\text{O}_3 \geq 99.5\%$)
Internal volume	
DN 16 ISO-KF	$\leq 3.7 \text{ cm}^3$
4 VCR male	$\leq 6.1 \text{ cm}^3$
4 VCR female	$\leq 5.6 \text{ cm}^3$
8 VCR female	$\leq 5.1 \text{ cm}^3$
Admissible pressure (absolute)	
$\geq 500 \text{ Torr/mbar (F.S.)}$	4 bar
50 ... 200 Torr/mbar (F.S.)	3 bar
10 ... 30 Torr/mbar (F.S.)	2 bar
Bursting pressure (absolute)	6 bar
<hr/>	
Temperature compensated range	+10 °C ... +50 °C
Admissible temperatures	
Storage	-20 °C ... +85 °C
Operation	0 °C ... +70 °C
Bakeout (not in operation)	$\leq 110 \text{ °C}$ at the flange
Relative humidity	$\leq 80\%$ at temperatures $\leq +31 \text{ °C}$ decreasing to 50% at +40°C
Use	indoors only, altitude up to 4000 m NN
Degree of protection	IP 40
<hr/>	

Dimensions [mm]

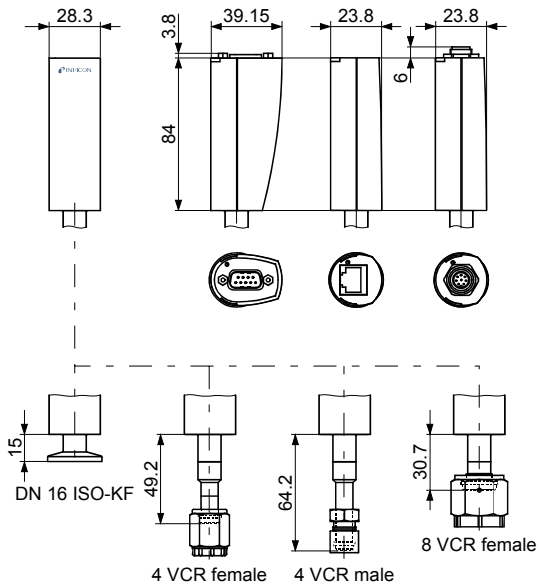

Weight

≤159 g

Analog Measuring Signal vs. Pressure

Pressure p

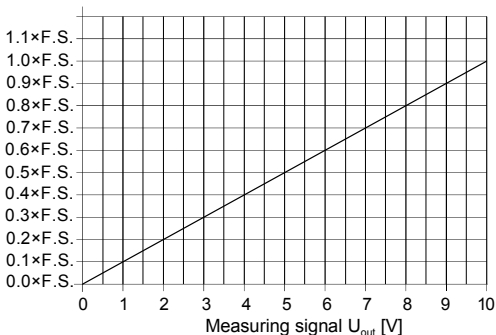

$$p = (U_{out} / 10 \text{ V}) \times p (\text{F.S.})$$

Conversion Torr \leftrightarrow Pascal

	Torr	mbar ³⁾	Pa ³⁾
c	1.00	1013.25 / 760 = 1.3332...	101325 / 760 = 133.3224...

Example: Gauge with 10 Torr F.S.
Measuring signal $U_{out} = 6 \text{ V}$

$$\begin{aligned}
 p &= (6 \text{ V} / 10 \text{ V}) \times 10 \text{ Torr} \\
 &= 0.6 \times 10 \text{ Torr} = \mathbf{6 \text{ Torr}}
 \end{aligned}$$

³⁾ Source: NPL (National Physical Laboratory)
Guide to the Measurement of Pressure and Vacuum, ISBN 0904457x /
1998

3 Installation



WARNING



WARNING: fragile components

The ceramic sensor may be damaged by impacts.

Do not drop the product and prevent shocks and impacts.

3.1 Vacuum Connection



DANGER



DANGER: overpressure in the vacuum system
>1 bar

Injury caused by released parts and harm caused by escaping process gases can result if clamps are opened while the vacuum system is pressurized.

Do not open any clamps while the vacuum system is pressurized. Use the type clamps which are suited to overpressure.



DANGER



DANGER: overpressure in the vacuum system
>2.5 bar

KF flange connections with elastomer seals (e.g. O-rings) cannot withstand such pressures. Process media can thus leak and possibly damage your health.

Use O-rings provided with an outer centering ring.

DANGER

DANGER: protective ground

Products that are not correctly connected to ground can be extremely hazardous in the event of a fault.

Electrically connect the gauge to the grounded vacuum chamber. This connection must conform to the requirements of a protective connection according to EN 61010:

- VCR flanges fulfill this requirement.
- For gauges with a KF flange, use a conductive metallic clamping ring.

Caution

Caution: vacuum component

Dirt and damages impair the function of the vacuum component.

When handling vacuum components, take appropriate measures to ensure cleanliness and prevent damages.

Caution

Caution: dirt sensitive area

Touching the product or parts thereof with bare hands increases the desorption rate.

Always wear clean, lint-free gloves and use clean tools when working in this area.



Mount the gauge so that no vibrations occur. The gauge may be mounted in any orientation. To keep condensates and particles from getting into the measuring chamber preferably choose a horizontal to upright position and possibly use a seal with a centering ring and filter. If adjustment should be possible after the gauge has been installed, be sure to install it so that the button can be accessed with a pin (→ 20).

Remove the protective lid and connect the product to the vacuum system.

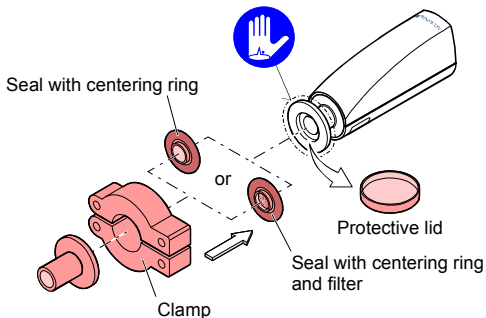

Keep the protective lid.

3.2 Power Connection



Make sure the vacuum connection is properly made (→  13).



DANGER



The gauge may only be connected to power supplies, instruments or control devices that conform to the requirements of a grounded protective extra-low voltage (SELV) and limited power source (LPS), Class 2. The connection to the gauge has to be fused ⁴⁾.



Ground loops, differences of potential, or EMC problems may affect the measurement signal. For optimum signal quality, please do observe the following notes:

- Use an overall metal braided shielded cable. The connector must have a metal case.
- Connect the cable shield to ground at one side via the connector case. Make sure the connector case has direct contact to the cable's shield on its whole circumference. Do not connect the other side of the shield.
- Connect the supply common with protective ground directly at the power supply.
- Use differential measurement input (signal common and supply common conducted separately).
- Potential difference between supply common and housing ≤ 16 V (overvoltage protection).

⁴⁾ INFICON controllers fulfill this requirement.

3.2.1 FCC68, 8-pin Connector

If no sensor cable is available, make one according to the following diagram. Connect the sensor cable (cable → 9).

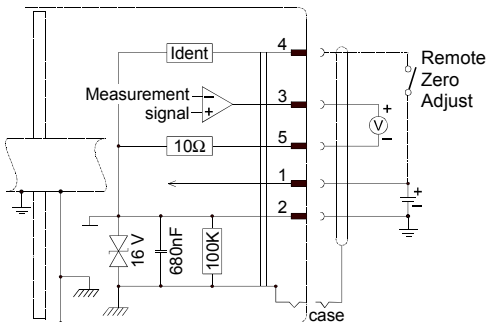

Electrical connection

Pin 1	Supply
Pin 2	Supply common GND
Pin 3	Signal output (measurement signal)
Pin 4	Gauge identification or Remote Zero Adjust
Pin 5	Signal common
Pin 6	N.C.
Pin 7	N.C.
Pin 8	N.C.
case	Connector case

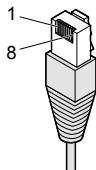

8-pin
FCC68
connector

3.2.2 D-Sub, 9-pin Connector

If no sensor cable is available, make one according to the following diagram. Connect the sensor cable (cable → 9).

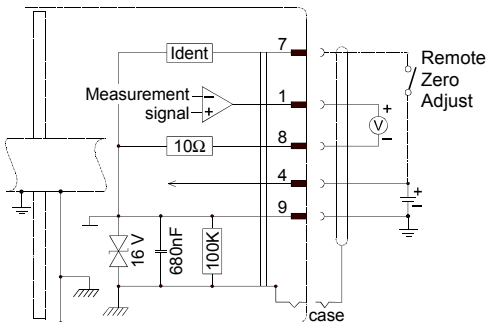

Electrical connection

Pin 1	Signal output (measurement signal)
Pin 2	N.C.
Pin 3	N.C.
Pin 4	Supply
Pin 5	N.C.
Pin 6	N.C.
Pin 7	Gauge identification or Remote Zero Adjust
Pin 8	Signal common
Pin 9	Supply common GND
case	Connector case

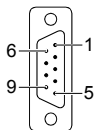

9-pin
D-Sub
female
soldering
side

3.2.3 Binder M12, 8-pin

If no sensor cable is available, make one according to the following diagram. Connect the sensor cable (cable → 9).

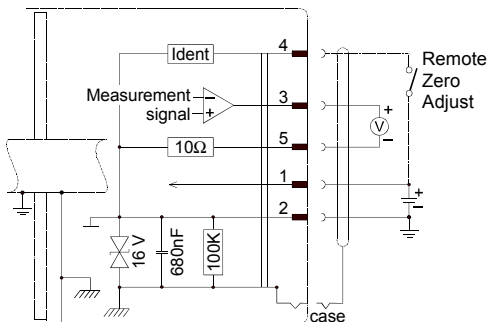

Electrical connection

Pin 1	Supply
Pin 2	Supply common GND
Pin 3	Signal output (measurement signal)
Pin 4	Gauge identification or Remote Zero Adjust
Pin 5	Signal common
Pin 6	N.C.
Pin 7	N.C.
Pin 8	N.C.
case	Connector case

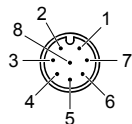

8-pin
Binder M12
female
soldering
side

4 Operation

Put the gauge into operation. If you are using an INFICON controller, define the measurement range (→  [2], [3], [4]).

Warm-up time: approx. 1 minute.

4.1 Zeroing the Gauge

The gauge is factory calibrated while "standing upright". It requires no maintenance.

Due to mounting orientation, long time operation or contamination, a zero drift could occur and zero adjustment may become necessary.

For adjusting the zero, operate the gauge under the same constant ambient conditions and in the same mounting orientation as normally.



If the gauge is operated via a controller, the zero of the whole measuring system has to be adjusted on the controller: first, adjust the zero of the gauge and then, the zero of the controller.

4.1.1 Zero Adjustment

The zero can be adjusted via

- the button on the gauge, or
- the digital input "Remote Zero Adjust " (briefly apply the supply voltage to pin 7 (D-Sub connector) or to pin 4 (FCC68 and Binder M12 connector)), or
- an INFICON Vacuum Gauge Controller (VGC series).

- 1** Evacuate the gauge to a pressure according to the table below:

F.S.	Recommended final pressure for zero adjustment		
1100 mbar	–	$<6.65 \times 10^0$ Pa	$<5 \times 10^{-2}$ mbar
1000 Torr/mbar	$<5 \times 10^{-2}$ Torr	$<6.65 \times 10^0$ Pa	$<5 \times 10^{-2}$ mbar
200 Torr/mbar	$<10^{-2}$ Torr	$<1.33 \times 10^0$ Pa	$<10^{-2}$ mbar
100 Torr/mbar	$<5 \times 10^{-3}$ Torr	$<6.65 \times 10^{-1}$ Pa	$<5 \times 10^{-3}$ mbar
50 Torr/mbar	$<2.5 \times 10^{-3}$ Torr	$<3.33 \times 10^{-1}$ Pa	$<2.5 \times 10^{-3}$ mbar
20 Torr/mbar	$<10^{-3}$ Torr	$<1.33 \times 10^{-1}$ Pa	$<10^{-3}$ mbar
10 Torr/mbar	$<5 \times 10^{-4}$ Torr	$<6.65 \times 10^{-2}$ Pa	$<5 \times 10^{-4}$ mbar

If the final pressure in the gauge is too high for zero adjustment ($>25\%$ of the F.S.), the zero cannot be reached.

- 2** Briefly press the button with a pin (max. $\varnothing 1.1$ mm). The zero adjustment runs automatically (duration ≤ 8 s).

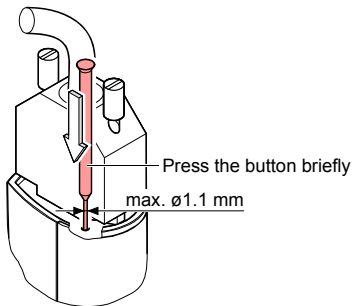

After zero adjustment the gauge automatically returns to measurement mode.

5 Deinstallation



WARNING



WARNING: fragile components
The ceramic sensor may be damaged by impacts.
Do not drop the product and prevent shocks and impacts.



DANGER



DANGER: contaminated parts
Contaminated parts can be detrimental to health and environment.
Before beginning to work, find out whether any parts are contaminated. Adhere to the relevant regulations and take the necessary precautions when handling contaminated parts.



Caution



Caution: vacuum component
Dirt and damages impair the function of the vacuum component.
When handling vacuum components, take appropriate measures to ensure cleanliness and prevent damages.



Caution



Caution: dirt sensitive area

Touching the product or parts thereof with bare hands increases the desorption rate.

Always wear clean, lint-free gloves and use clean tools when working in this area.

- 1 Vent the vacuum system.
- 2 Put the gauge out of operation.
- 3 Disconnect the sensor cable.
- 4 Remove the gauge from the vacuum system and install the protective lid.

6 Maintenance, Repair

The product requires no maintenance.



Gauge failures due to contamination or wear and tear are not covered by the warranty.

We recommend checking the zero at regular intervals.

INFICON assumes no liability and the warranty becomes null and void if any repair work is carried out by the end-user or third parties.

7 Returning the Product



WARNING



WARNING: forwarding contaminated products
Contaminated products (e.g. radioactive, toxic, caustic or microbiological hazard) can be detrimental to health and environment.

Products returned to INFICON should preferably be free of harmful substances. Adhere to the forwarding regulations of all involved countries and forwarding companies and enclose a duly completed declaration of contamination^{*)}.

^{*)} Form under www.inficon.com

Products that are not clearly declared as "free of harmful substances" are decontaminated at the expense of the customer.

Products not accompanied by a duly completed declaration of contamination are returned to the sender at his own expense.

8 Disposal



DANGER

DANGER: contaminated parts

Contaminated parts can be detrimental to health and environment.

Before beginning to work, find out whether any parts are contaminated. Adhere to the relevant regulations and take the necessary precautions when handling contaminated parts.



WARNING

WARNING: substances detrimental to the environment

Products or parts thereof (mechanical and electric components, operating fluids etc.) can be detrimental to the environment.





Dispose of such substances in accordance with the relevant local regulations.

Separating the components

After disassembling the product, separate its components according to the following criteria:

- Contaminated components
Contaminated components (radioactive, toxic, caustic or biological hazard etc.) must be decontaminated in accordance with the relevant national regulations, separated according to their materials, and disposed of.
- Other components
Such components must be separated according to their materials and recycled.

Further Information

-  [1] www.porter-inficon.com
 Product Information
 Porter™ CDG020D
 INFICON AG, LI-9496 Balzers, Liechtenstein
-  [2] www.inficon.com
 Operating Manual
 Vacuum Gauge Controller VGC032
 tinb02e1
 INFICON AG, LI-9496 Balzers, Liechtenstein
-  [3] www.inficon.com
 Operating Manual
 Single-Channel Controller VGC401
 tinb01e1
 INFICON AG, LI-9496 Balzers, Liechtenstein
-  [4] www.inficon.com
 Operating Manual
 Two- & Three-Channel Measurement and Control Unit
 VGC402, VGC403
 tinb07e1
 INFICON AG, LI-9496 Balzers, Liechtenstein

ETL Certification



ETL LISTED

The product CDG020D complies with the requirements of the following Standards:

UL 61010-1, Issued: 2004/07/12 Ed: 2
 Rev: 2005/07/22
 CAN/CSA C22.2#61010-1,
 Issued: 2004/07/12

EC Declaration of Conformity



We, INFICON, hereby declare that the equipment mentioned below complies with the provisions of the Directive relating to electromagnetic compatibility 2004/108/EC and the Directive on the restriction of the use of certain hazardous substances in electrical and electronic equipment 2011/65/EU.

Capacitance Diaphragm Gauge Porter™ CDG020D

Standards

Harmonized and international/national standards and specifications:

- EN 61000-6-2:2005 (EMC: generic immunity standard)
- EN 61000-6-3:2007 (EMC: generic emission standard)
- EN 61010-1:2001 (Safety requirements for electrical equipment for measurement, control and laboratory use)

Manufacturer / Signatures

INFICON AG, Alte Landstraße 6, LI-9496 Balzers

27 June 2012

27 June 2012



Dr. Urs Wälchli
Managing Director

Alex Nef
Product Manager

Original: German tina80d1 (2012-06)



tina80e1



LI-9496 Balzers
Liechtenstein
Tel +423 / 388 3111
Fax +423 / 388 3700
reachus@inficon.com

www.inficon.com