SQC-122

Thin Film Deposition Controller

User's Guide

Version 1.4

© Copyright Sigma Instruments, Inc. 1999 - 2001



Safety Information

Read this manual before installing, operating, or servicing equipment. Do not install substitute parts, or perform any unauthorized modification of the product. Return the product to Sigma Instruments for service and repair to ensure that safety features are maintained.

Safety Symbols

WARNING: Calls attention to a procedure, practice, or condition that could possibly cause bodily injury or death.

CAUTION: Calls attention to a procedure, practice, or condition that could possibly cause damage to equipment or permanent loss of data.



Refer to all manual Warning or Caution information before using this product to avoid personal injury or equipment damage.



Hazardous voltages may be present.



Earth ground symbol.



Chassis ground symbol.



Equipotential ground symbol.

Warranty Information

This Sigma Instruments product is warranted against defects in material and workmanship for a period of 1 year from the date of shipment, when used in accordance with the instructions in this manual. During the warranty period, Sigma Instruments will, at its option, either repair or replace products that prove to be defective.

Limitation of Warranty

Defects from, or repairs necessitated by, misuse or alteration of the product, or any cause other than defective materials or workmanship are not covered by this warranty. NO OTHER WARRANTIES ARE EXPRESSED OR IMPLIED, INCLUDING BUT NOT LIMITED TO THE IMPLIED WARRANTIES OF MERCHANTABILITY AND FITNESS FOR A PARTICULAR PURPOSE. UNDER NO CIRCUMSTANCES SHALL SIGMA INSTRUMENTS BE LIABLE FOR CONSEQUENTIAL OR OTHER DAMAGES RESULTING FROM A BREACH OF THIS LIMITED WARRANTY, OR OTHERWISE.

Return Policy

The purchaser may return this product in new condition within 30 days after shipment for any reason. In case of return, purchaser is liable and responsible for all freight charges in both directions.

Sigma Instruments
1318 Duff Drive
Fort Collins, CO 80524 USA
970-416-9660
970-416-9330 (fax)

Table of Contents

Chapter 1 Quick Start

1.0 Introduction.....	1-1
1.1 Thin Film Process Overview.....	1-1
1.2 System Connections.....	1-2
1.3 Front Panel.....	1-3
1.4 Rear Panel.....	1-4
1.5 Installation.....	1-5
1.6 Process Setup.....	1-6
1.7 Depositing a Film.....	1-8

Chapter 2 Operation

2.0 Introduction.....	2-1
2.1 Definitions.....	2-1
2.2 Defining a Film.....	2-1
2.3 Defining a Process.....	2-5
2.4 Sensor Setup.....	2-7
2.5 Source Setup.....	2-10
2.6 Running a Process.....	2-11
2.7 Loop Tuning.....	2-15
2.8 Troubleshooting.....	2-17

Chapter 3 Menus

3.0 Introduction.....	3-1
3.1 Main Menu.....	3-2
3.2 Next Menus.....	3-4
3.3 Quick Setup Menu.....	3-5
3.4 Process Menus.....	3-7
3.5 Film Menus.....	3-11
3.6 System Parameters Menu.....	3-18
3.7 I/O Setup.....	3-21

Chapter 4 Options

4.0 Introduction.....	4-1
4.1 Option Card Installation.....	4-1
4.2 Four Sensor Card Configuration.....	4-1
4.3 Full Rack Extender Installation.....	4-2

Appendix

- A. Material Parameters
- B. Specifications
- C. I/O Connections
- D. Handheld Remote Controller
- E. Declaration of Conformity

1.0 Introduction

The SQC-122 is a multi-channel quartz crystal monitor and deposition controller. It measures up to six 1MHz to 6 MHz quartz crystal sensors, and controls two evaporation sources. Twenty-five processes, consisting of 250 layers and 25 materials, can be stored for easy retrieval. Eight process control relays, and eight digital inputs are easily configured to support a broad range of external functions, including source pocket rotation.

The SQC-122 can also be controlled via the standard RS-232 interface and Windows control program. An optional handheld remote power control is also available.

This chapter will aid you in the initial setup and operation of your system. Please review the entire manual for detailed operational, programming, and safety information.

1.1 Thin Film Process Overview

The SQC-122 stores the recipes, and provides the operating functions, required to control thin film deposition processes. A typical thin film deposition cycle is shown below.

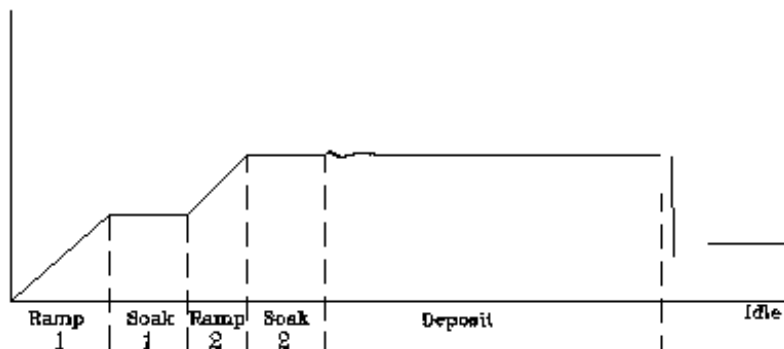

The cycle can be broken into three distinct phases: pre-conditioning (ramp/soak), deposition, and post-conditioning (feed/idle). During pre-conditioning, power is supplied to prepare the evaporation source for deposition. Once the pre-conditioning period expires, material deposition begins. During deposition, the PID loop adjusts the evaporation source power as required to achieve the desired deposition rate. When the desired thickness is reached, the evaporation source is set to idle power. At this point the process may be complete, or deposition of another film layer may begin.

1.2 Front Panel

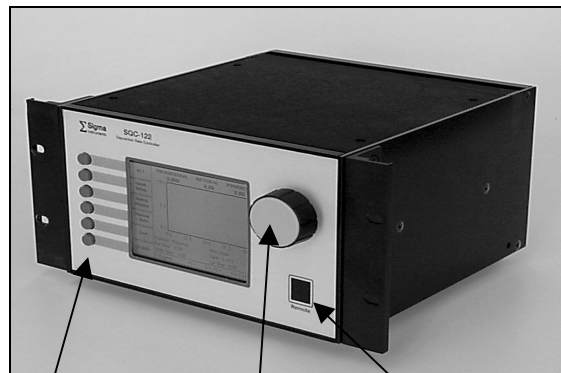

SoftKeys Control Knob Remote Jack

Front Panel Controls

SoftKeys

Provide access to instrument operations and setup menus. The functions of the SoftKeys change to adapt to different operations and are displayed on the left of the screen.

Control Knob

Used to adjust values and select menu items. Pushing the control knob stores the current setting and moves to the next.

Remote Jack

Connection jack for the optional handheld remote control module. See Appendix D.

1.3 Rear Panel

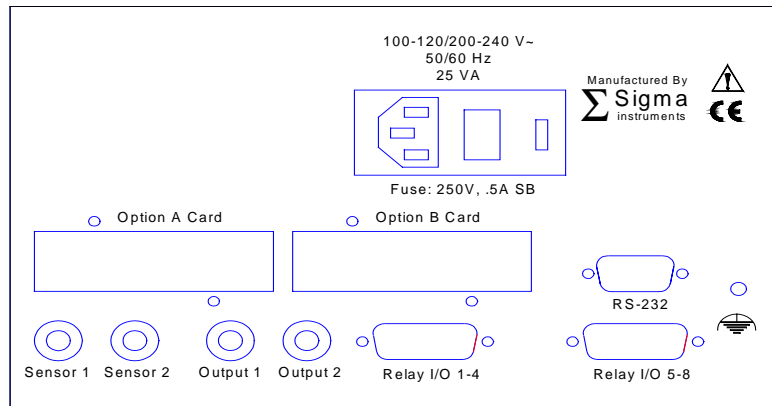

Rear Panel Connections

- Sensor 1 & 2** Connects to quartz crystal sensor remote oscillator.
- Output 1 & 2** Connects the SQC-122 output to your evaporation supply control input.
- Option A Card** Provides an additional four sensor measurement channels. See Chapter 4 for information on installing the four sensor option card.
- Relay I/O (1-4)
Relay I/O (5-8)** Connects 8 relays and 8 digital inputs to external equipment for process control. See Appendix C for connections.
- RS-232** Connects to computer for programming and data acquisition.
-  Measurement ground terminal useful for common system and cable grounding.
- Power Input and Voltage Selector** **WARNING:** Select 115V for 100-120VAC, 230V for 200-240VAC.

WARNING: Use removable power cords only of the specified type and rating, attached to a properly grounded receptacle.

1.4 System Connections

This section identifies typical system components and their connection:

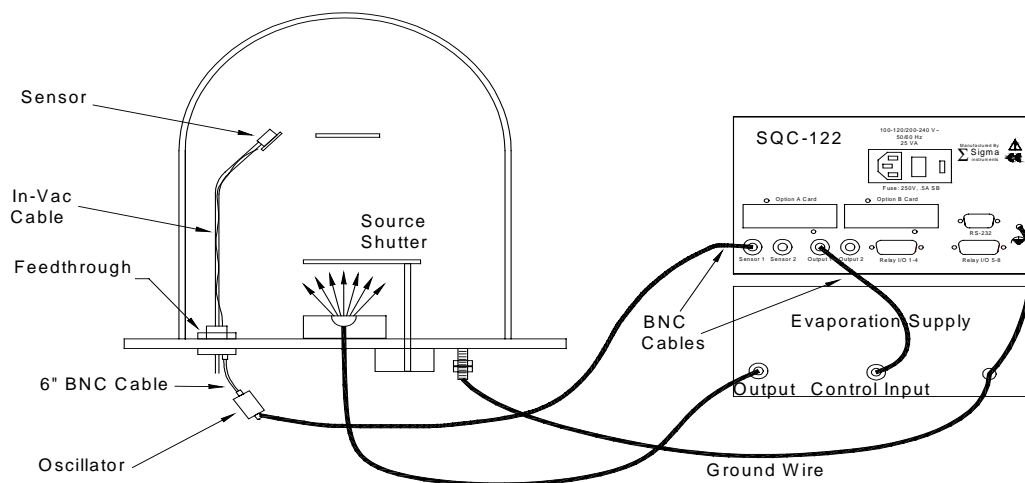

System Components

Sensor	Holds the quartz crystal used to measure rate and thickness. Crystals must be replaced occasionally.
In-Vac Cable	A coaxial cable that connects the sensor to the feedthrough.
Feedthrough	Provides isolation between vacuum and atmosphere for electrical and cooling lines.
6" BNC Cable	Provides a flexible connection from the feedthrough to the oscillator. Keep this cable as short as possible.
Oscillator	Contains the electronics to operate the quartz crystal. Total cable length to the crystal should be under 40".
Sensor Input BNC Cable	Connects the oscillator to the SQC-122 input. Lengths up to 100' are acceptable.
Control Output BNC Cable	Connects the SQC-122 output to the evaporation source's control voltage input. Keep the length below 10'.
Ground Wire	A wire, typically braided, that connects the vacuum system to the SQC-122 ground terminal.

1.5 Installation

WARNING: Care should be exercised to route SQC-122 cables as far as practical from other cables that carry high voltages or generate noise. This includes other line voltage cables, wires to heaters that are SCR-controlled, and cables to source power supplies that may conduct high transient currents during arc down conditions.

Rack Installation

The SQC-122 occupies a 5.25" high, half-rack space. An optional installation kit is available to adapt to a full rack (see Chapter 4). Install the unit in a 19" rack with the supplied hardware.

Power Connection

WARNING: Verify that the Voltage Selector Switch, located next to the power switch, matches your mains supply voltage.

WARNING: Verify that the power cable provided is connected to a properly grounded mains receptacle.

Sensor Input Connections

Connect the BNC cables and oscillators from your vacuum chamber feedthrough to the desired SQC-122 sensor inputs.

Source Output Connections

Connect the BNC cables from the SQC-122 output connectors to your evaporation supply control input.

Digital I/O Connections

Refer to Appendix C for details on wiring digital I/O to the SQC-122 Relay I/O connectors.

Computer Connection

If you would like to use the Windows software to collect data or program the SQC-122, attach a 9 pin straight-thru cable from the RS-232 connector to your computer's serial port.

1.6 Process Setup

Follow these steps to build a process from the main (also called “power up”) screen.

Note: *If you are prompted for a password, use the switches along the left of the screen to enter the password. The top switch is “1”, the bottom switch is “6”. If you forget the password, see the System Parameters section for password setup.*

Power On Move the rear panel power switch to the On (I) position. The SQC-122 will briefly display its initialization information, then go to normal operating mode.

Select Quick Setup Press the **Quick Setup** SoftKey to view the quick setup parameters for the current process.

If no Quick Setup option is visible, no processes are defined in the SQC-122. In that case, press **Film Menu**, then scroll the cursor until an <Empty> film is selected. Press **Create** to create a new film, then press **Main Screen**. Now press **Process Menu**, then **Create**, then **Edit**. Select **Insert Layer**, scroll to your new film and press **Enter**. Now press **Prev Menu** twice to return to the Main Menu.

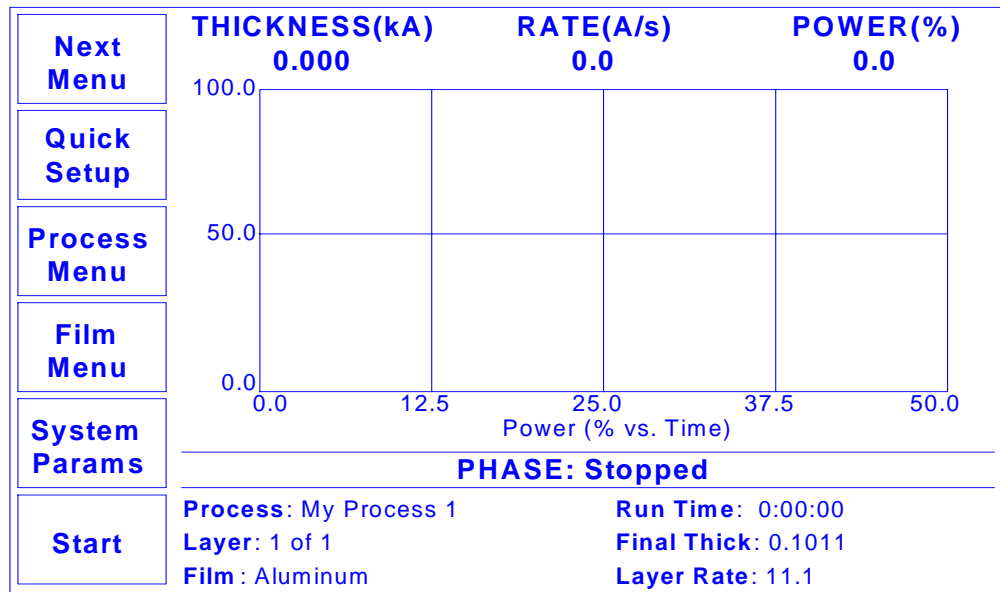

Main Screen

Edit Mode

To edit a setting in any menu, turn the control knob to scroll to the desired setting, then press the **Edit** SoftKey.

In Edit mode, the cursor moves to the setting value and the SoftKey functions change to show:

Next: Store the parameter and move to next parameter for editing.

Cancel: Stop editing and return the selected parameter to its previous value.

Enter: Stop editing and save values for selected parameter.

In Edit mode, adjust the control knob to set the desired parameter value.

Edit Layer 1

Spend some time navigating through the Quick Setup parameters and editing values. When you are comfortable, be sure your values for Layer 1 match those shown below.

Exit to Main	THICKNESS(kA)	RATE(A/s)	POWER(%)
	0.000	0.0	0.0
My Process 1 -> Layer 1 ->			
Edit	Parameter	Value	Units
	Init Rate	11.1	A/s
	Fnl Thk	0.101	kA
	P Term	50	None
	I Term	0.7	Sec.
	D Term	0.0	Sec.
	Sensor 1	On	On/Off
	Sensor 2	On	On/Off
	Output	Out1	Out1/Out2
	Max. Power	76.0	%
	Slew Rate	10.0	%
	Material	Copper	

Quick Setup Menu

Exit to Main

Press **Exit to Main** to return to the main screen.

1.7 Depositing a Film

If you have followed this Quick Start chapter, you are ready to deposit a film.

Note: You can simulate the steps below, without actually depositing a film, by going to the System Parameters Menu and selecting Simulate Mode ON. Simulate mode is useful for testing processes before applying power to the evaporation supply. See Section 3.6 for System Parameters Menu information.

Verify Output Operation

From the Main Menu, press the **Next Menu** SoftKey. Then, press **Auto/Manual** to display Manual/Auto. Slowly turn the control knob to increase the control voltage to your evaporation supply. Verify that the Power(%) reading in the display upper right-hand corner approximates the actual output of your evaporation supply. If not, check your hookup (1.5), and refer to Scale Voltage (3.6).

Verify Sensor Operation

Press **Next Menu** until the Switch Displays option is shown. Press **Switch Displays** to display Sensor 1 and Sensor 2 in the lower status section of the screen. At least one sensor should be ON and display a % life of over 50%. If not, check your sensor connections (1.5), and refer to Min/Max Frequency (3.6).

Enter Auto Mode

Press the **Next Menu** key twice to display the output screen. Press **Manual/Auto** until Auto/Manual is displayed.

Show Power Graph

Press **Next Menu** once more. Press the **Next Graph** SoftKey until the graph shows Power (% vs. Time).

Start Process

Press the **Start** key to start the deposition process. Graphing of the output power should start.

Caution: Observe the output power versus your evaporation supply's actual output. If there is a problem, press the **Stop** SoftKey immediately.

If the rate and thickness readings do not match your expectations, refer to Appendix A for information on Density and Z-Factor, and Section 2.4 for Tooling.

Please take time to review the remainder of this manual for detailed operational, programming, and safety information.

This page left blank for your notes.

2.0 Introduction

This chapter describes common tasks associated with operating the SQC-122. It assumes that you understand basic operation of the menus and parameter setup as described in Chapter 1. Detailed definitions of unfamiliar setup parameters can be found under the appropriate menu description in Chapter 3.

2.1 Definitions

Several terms will be used repeatedly throughout this manual. It is important that you understand each of these terms.

Material: A physical material to be deposited. A database of approximately 100 materials is stored in the SQC-122, and additional materials may be added using the setup software. Three parameters completely define a material: Name, Density, and Z-Factor. A table of common materials, their density, and Z-Factor is listed in Appendix A.

Film: A film describes in detail how a material will be deposited. It includes the material definition and all of the preconditioning, deposition, and post conditioning variables necessary to accurately deposit the material. Because the film definition does not include rate and thickness information, a film can be used in several different processes. The SQC-122 stores up to 25 films.

Layer: Layers are the basic building blocks of processes. A layer consists of a film and the thickness and rate that it be deposited in a process.

Process: A deposition process is a sequence of layers (i.e. films, materials) to be deposited. The SQC-122 can store up to 25 processes, consisting of a total of 250 layers.

2.2 Defining a Film

A film is a material to be deposited, plus all of its associated setup parameters. Keep in mind that a film can be used in multiple processes. Editing a film's parameters will cause changes to every process where the film is used.

To define a film, select **Film Menu** on the main screen. A list of 25 films (or <Empty>) will be displayed. To define a new film, scroll to <Empty> and press **Create**. A new Film# is added to the list of existing films (you can use the SQC-122 setup software later to assign descriptive film names). Press **Edit** to display the parameters for this film.

The most commonly modified parameters are shown on the first film parameters screen. Additional parameters can be accessed by pressing Film Conds (film conditioning) or Deposit Controls.

	THICKNESS(kA) 0.000	RATE(A/s) 0.0	POWER(%) 0.0
Exit to Main	My Process 1 Editing: Aluminum		
Prev Menu	Parameter	Value	Units
Edit	P Term	50	None
Film Conds.	I Term	0.7	Sec.
Deposit Controls	D Term	0.0	Sec.
	Sensor 1	On	On/Off
	Sensor 2	On	On/Off
	Film Tooling	100	%
	Output	Out1	Out1/Out2
	Pocket	1	
	Max Power	76.0	
	Slew Rate	10.0	%
	Crystal Quality	Disabled	

Film Edit Menu

Scroll to the end of the list (Z-Factor), then scroll back up to Material. Press **Edit** to scroll through the list of available materials. Notice that the Density and Z-Factor are updated automatically as a new material appears.

Select the desired material and press **Enter**. You could change the Density and Z-Factor for the selected material now, but it is unlikely those values are wrong. To add a material name that is not listed, you must use the SQC-122 setup software.

Once the material is selected, set up the source parameters. Scroll to Output and select the SQC-122 rear panel output that is connected to the source evaporation supply. If a source pocket indexer is being used, assign it also.

Now assign the Max Power and Slew Rate appropriate for this material and your power supply. For now, set both to 100%. Set them to lower values later if you find that small power changes cause excessively large changes in deposition rate.

The SQC-122 can use multiple sensors to measure a film's deposition rate and thickness. If multiple sensors are selected, an average of the sensors is used. Set each sensor that will be used to measure this film to ON. Alternately, you might want to use a dual shuttered sensor in case of crystal failures. See the Film Menu section of Chapter 3 for instructions on setting up a primary/secondary dual sensor.

The PID parameters control the response of the SQC-122 to changes in deposition rate. These values are unique to each deposition chamber setup, and to a lesser extent to each material.

The P Term is proportional (or gain), the % process rate change divided by the % input power change. The I Term (integral) sums the rate deviations over time to more accurately achieve the rate setpoint. The D Term (derivative) speeds response to sudden changes in rate. Volumes have been written on determining the proper PID settings. See the section on Loop Tuning later in this chapter for a common PID loop tuning procedure. For now, you should probably leave these values at their defaults.

Press **Film Conds** to enter the film conditioning menu. Film preconditioning is used to prepare a material for deposition. When the film deposition is complete, post conditioning ramps power down to an idle level. It may also ramp power to a level appropriate for wire feeding new material. Refer to the Thin Film Process Overview in Chapter 1 for an illustration of pre and post conditioning.

Exit to Main	THICKNESS(kA) 0.000	RATE(A/s) 0.0	POWER(%) 0.0
My Process 1 Editing: Aluminum			
Prev Menu	Parameter	Value	Units
Edit	Ramp1 Power	50	%
	Ramp1 Time	0.7	h:mm:ss
	Soak1 Time	0.0	h:mm:ss
	Ramp2 Power	On	%
	Ramp2 Time	On	h:mm:ss
	Soak2 Time	Out1	h:mm:ss
	Feed Power	75.0	%
	Ramp Time	10.0	h:mm:ss
	Feed Time	0:00:00	h:mm:ss
	Idle Power	2.90	%
	Ramp Time	0.950	h:mm:ss

Film Conditioning Menu

Set the Ramp 1 Power and Time to values that will slowly bring the material to a near molten state. Set the Soak 1 Time to a value that will allow the material to homogeneously achieve the state. Ramp 2 is used to slowly bring the material to a power level that nearly matches the desired deposition power. Use Soak 2 to hold the material at that level until deposition (i.e. rate control) begins.

If you use wire feed to replenish material after deposition, set the Feed Power and times as required. Idle typically ramps output power back toward zero at the end of a process.

From the Film Conds menu, press **Prev Menu** to return to the main Film Params menu. Now press **Deposit Controls**. The Deposit Controls menu contains parameters that modify operation during the deposition phase.

Exit to Main	THICKNESS(kA) 0.000	RATE(A/s) 0.0	POWER(%) 0.0
	Current: Process 1		EDITING: Film 1
Prev Menu	Parameter	Value	Units
	Shutter Delay	0:01:00	h:mm:ss
	Capture	20.0	%
Edit	Control Error	(Ignore, Stop, Hold)	
	Setting	Hold	
	Error	18.0	%
	Rate Sampling	(Cont,Time,Acc based)	
	Setting	Undefined	
	Accuracy Based	0.0	%

Deposition Controls Menu

Shutter delay causes the SQC-122 to delay opening the shutter until the process has stabilized at the desired deposition rate. The time value is the maximum amount of time to wait, before an error is sensed. Capture is the % rate deviation that must be achieved to open the shutter and go to the Deposit phase. Capture will override the shutter delay if accuracy is reached. Set Shutter Delay and Capture to zero to disable this feature.

If the SQC-122 is unable to maintain the desired deposition rate (for example, out of material or a bad sensor), one of three actions is possible. Keep trying (Ignore), set power to zero to halt deposition (Stop), or maintain constant power (Hold) and extrapolate thickness from the last good rate reading. Until your process is known and stable, it is best to leave the Control Error setting on Ignore.

Rate sampling can extend sensor life in high rate processes. Select Cont (continuous) to disable rate sampling. A Time selection closes the shutter for a fixed time, then opens the shutter for a fixed time to sample the rate. Acc Based (accuracy based) sampling closes the shutter for a fixed time, then opens the shutter until the desired rate is achieved. Rate Sampling assumes a very stable process!

Each film parameter has been set. Press **Exit to Main** to return to the Main Screen.

2.3 Defining a Process

A process is a sequence of film layers deposited to achieve a particular thin film characteristic. A few processes, each consisting of a few layers, may be adequate for a production facility. For research or laboratory use, the SQC-122 can store up to 25 processes to a total of 250 layers.

You should define each of the films that will make up the layers of the process before starting process definition. See the previous section for instructions on defining films.

To define a process, select **Process Menu** on the main screen. A list of 25 processes (or <Empty>) will be displayed. To define a new process, scroll to <Empty> and press **Create**. A new Process# is added to the list of existing processes (use the SQC-122 setup software to assign descriptive process names). Press **Select**, then **Edit** to display the sequence of layers and films that comprise the selected process.

To add a layer, scroll to the desired location in the layer sequence, and press **Insert Layer**. Select a film for this layer from the list and press **Enter**. Once a film is assigned to a process layer, you cannot change the film. Instead, cut the layer, then insert a new layer and select the desired film. To edit a layer, highlight it, then press **Edit**.

Exit to Main	THICKNESS(kA)	RATE(A/s)	POWER(%)
	0.000	0.0	0.0
	My Process 1 Layer 1 ->		
Prev Menu	Parameter	Value	Units
	Init. Rate	5.0	A/s
Edit	Fnl Thk	0.500	kA
	Time Setpoint	0:01:00	h:mm:ss
	Thickness Limit	0.400	kA
	Start Mode	Auto	Man/Auto
	Ramp1	Enabled	En/Dis
	Start Thickness	0.150	kA
	Ramp Time	0:00:30	h:mm:ss
	New Rate	3.5	A/s
	Ramp2	Disabled	En/Dis

Layer Edit Menu

Remember that most setup parameters are set in the Films Menu, and apply to every instance where the film is used. The layer parameters pertain only to this instance of the film, in this process.

Initial Rate and Final Thickness are the main process setpoints for this layer of material. Keep in mind that the SQC-122 zeroes thickness at the beginning of each layer. It is not a cumulative value.

Time Setpoint and Thickness Limit are arbitrary values that will activate a relay when they are reached.

Start mode allows you to have this layer start immediately on completion of the previous layer, Auto mode. Manual mode waits for a user signal via the front panel, RS-232, or digital input to start the layer.

Rate Ramps allow the deposition rate to change over time, under PID control. Each rate ramp has a starting thickness, an elapsed time to ramp to the new rate, and a new rate setpoint. Each process layer can have up to two rate ramps.

Press **Prev Menu** to return to the list of layers, or **Exit to Main** to return to the Main Screen.

2.4 Sensor Setup

The theory of operation for a quartz crystal sensor is quite simple. The sensor initially oscillates at its natural frequency, typically 6MHz. As material is deposited on the substrate, it is also deposited on the sensor. Depending on the density of the deposited material, and the amount of material deposited, the sensor's frequency will drop from its initial frequency. The rate and thickness can be calculated from this frequency shift.

Sensor setup involves selecting the sensor(s) to be used, setting the Min/Max crystal frequencies, and adjusting the Tooling Factor. Sensors are assigned to each film, as described in Section 2.2, Defining a Film. See Section 3.5 for information on setting up dual shuttered sensors.

In the **System Params** menu, Max Frequency is the initial frequency of a new crystal, typically 6.0e+06 Hz (6 MHz). Due to manufacturing tolerances, some crystals may oscillate above 6MHz initially, which would be detected as a sensor error. Setting the Max Frequency slightly above the nominal value, to say 6.1MHz, will avoid this problem with no effect on instrument accuracy.

Min Frequency is the frequency where the SQC-122 will flag a sensor as bad. For a 6MHz crystal, the Min Frequency is typically 5 MHz.

Crystal failure is often predicted by brief periods of "mode hopping," where the crystal briefly makes an abrupt change in frequency, or stops oscillating altogether. Some materials will cause crystals to fail or mode hop well before 5MHz. It is good practice to set the Min Frequency to a value that indicates crystal failure well before most crystals actually fail.

To better determine impending crystal failure, Crystal Quality and Stability parameters are also available for each Film. See Chapter 3, Film Menus for more information on setting Crystal Quality and Stability.

Sensor Tooling, also found in the **System Params** menu, adjusts for the difference in measured deposition rate between the sensor and the substrate being coated.

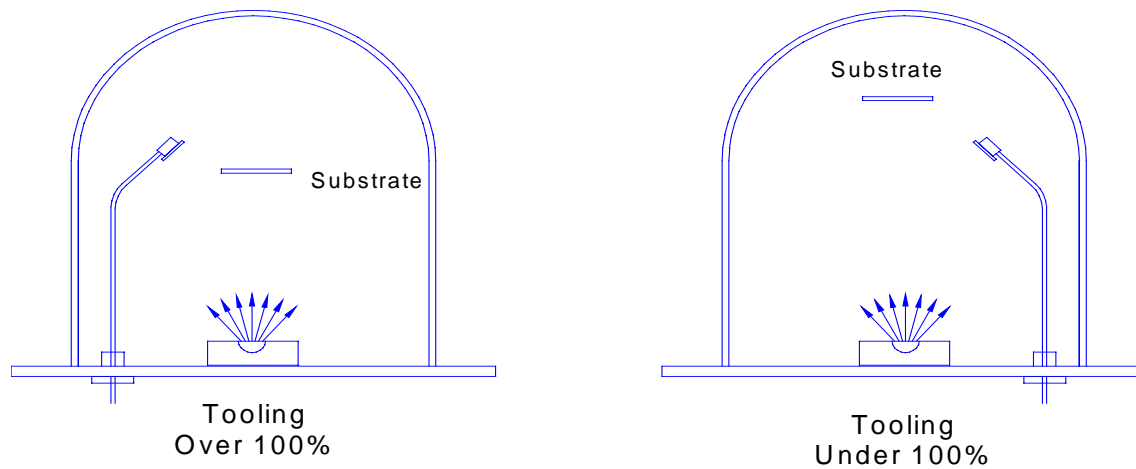

In the illustration above (left), the sensor will measure less rate or thickness than is actually deposited on the substrate because of its positioning. In the right illustration, the sensor will measure high. Tooling is the ratio of the actual substrate deposition rate or thickness, to that measured by the sensor.

Let's assume that at the end of deposition the sensor measures a thickness of 1.000 kÅ. But, suppose the actual substrate is deposited to 1.100 kÅ thickness (as determined by some other means, such as a stylus profilometer). Then the tooling for this sensor would be:

$$(1.100 / 1.000) \times 100 = 110$$

Xtal Tool 1 and 2 adjust the tooling for each individual sensor. It is particularly important when using sensor averaging to balance multiple sensors so that their measurements match.

System Tooling applies to the overall Rate and Thickness measurements of all sensors. It is sometimes used to adjust for some systematic difference in the actual vs. measured readings. In general, Crystal Tooling (Xtal Tool 1 and 2) should be used instead.

Once the sensor parameters are set, test your sensor setup to assure reliable readings at the SQC-122. A typical single sensor setup is shown below:

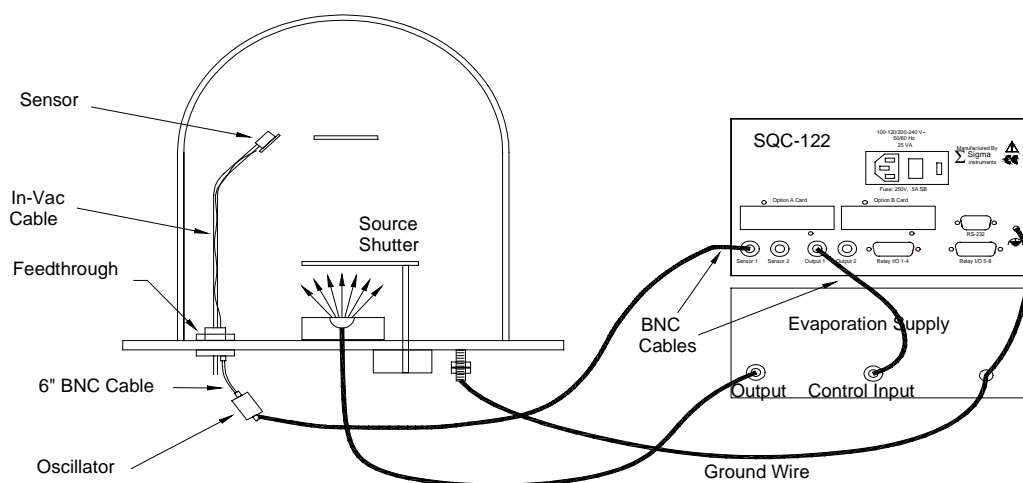

On the SQC-122, press **Next Menu** until the Sensor Info option is shown, then press **Sensor Info**.

Any connected sensor (whether programmed On or Off) should display its frequency and % remaining life, as defined by Min and Max Frequency setup. For a new sensor, the value should be near 100%. If the % Life is 0.00% or jumps around, check your cabling and the installation of the sensor in its holder.

Sigma supplies a small 5.5MHz “test crystal adapter” with each oscillator. If the % Life reading is not correct, remove the 6” BNC that is connected to your feedthrough at the oscillator. Connect the test crystal and adapter to the oscillator connector labeled feedthrough. For a typical setup of 6MHz Max Frequency and 5MHz Min Frequency, the % life display should be near 50%.

More information on locating system and sensor problems is described in the Troubleshooting section, later in this chapter.

2.5 Source Setup

The SQC-122 controls deposition rate by varying the control voltage to an external evaporation (source) supply. The previous illustration for sensor wiring also shows source supply wiring.

The SQC-122 control voltage output range is set in the **Systems Params** menu. For the supply connected to Output 1, set Scale 1 to the control voltage that corresponds to 100% output on the source supply. The SQC-122 uses 0 volts as 0% output, and the programmed value as 100% output. Scale values from –10 volts to 10 volts are possible.

If you find that very small changes in control voltage yield large changes in deposition rate, you can lower the Scale value to decrease the dynamic range. Also, each Film has a Max Power and Slew Rate parameter that may be used to customize response to that film.

2.6 Running a Process

Once a Process is defined with the desired Layers, and the sensors and source supply are properly connected, the deposition process is ready to run. The next section, on Loop Tuning, describes a method for initial process startup and optimization. This section describes the steps to select, start, and stop a process.

Note: *It is best (and safest!) to place the SQC-122 in Simulate mode when a process is first run. If the bottom SoftKey does not show Start Simulate, press **System Params** and turn Simulate ON.*

To select a process, the status bar must be showing Phase: Stopped. If any other phase is displayed, press the **Abort** SoftKey.

Press **Process Menu**, then use the scroll knob to highlight the desired process. If the third SoftKey shows Edit when a process is highlighted, then it is already the current process. Otherwise, press **Select** to set the highlighted process as the current process. You can press Edit to review the current process layers and their associated films. Press **Main Screen** to return to the main operating screen.

Press **Quick Setup** to review the most commonly adjusted parameters for the first layer of the process. Press **Next Layer** to review each layer in the current process.

	THICKNESS(kA)	RATE(A/s)	POWER(%)
	0.000	0.0	0.0
My Process 1 -> Layer 1-> Aluminum			
	Parameter	Value	Units
	Init Rate	11.1	A/s
Edit	Fnl Thk	0.101	kA
	P Term	50	None
	I Term	0.7	Sec.
Prev Layer	D Term	0.0	Sec.
	Sensor 1	On	On/Off
	Sensor 2	On	On/Off
Next Layer	Output	Out1	Out1/Out2
	Max. Power	76.0	%
	Slew Rate	10.0	%
	Material	Aluminum	

Quick Setup Menu

Press **Exit to Main** to return to the main operating screen.

While we're on the Main Menu screen, and before starting the selected process, let's cover the capabilities of the Next Menu screens.

Press **Next Menu** once to view the first Next Menu screen. This screen provides two important operator functions: Zero Thickness and Auto/Manual mode.

The **Zero** SoftKey can be used to zero the thickness reading at any time. It is not normally needed, since the SQC-122 automatically zeroes the thickness at the beginning of each layer. It is, however, useful when simulating a process and when operating in Manual mode.

The **Auto/Manual** key alternates between Automatic (PID) output control and Manual (user) output control. Auto/Manual indicates the process is in automatic control, and a key press will change to Manual control. Manual/Auto indicates Manual control; a key press changes to Automatic mode.

In Manual mode, the SQC-122 immediately starts the deposition phase for the current layer, whether the process was stopped or running. However, the PID loop is disabled and output power is controlled by the front panel control knob.

In Manual Mode, you will usually display the Rate Graph, then manually adjust the output power to achieve the desired deposition rate. It is easy to exceed a layer's Final Thickness setpoint in Manual mode, so watch the Thickness reading carefully. Manual mode is particularly useful for determining preconditioning power levels, and loop gain (discussed later in Loop Tuning).

Moving from Manual mode to Auto mode places the SQC-122 into automatic (PID) control. The PID control loop will try to achieve rate setpoint, so there may be a rapid change in output power.

Press **Next Menu** again to view the second Next Menu screen.

Next Graph selects which of three available graphs is displayed. The Power Graph is useful during preconditioning. The Rate graph shows the response of the control loop to process changes, such as when moving from preconditioning to deposition. The Rate Deviation Graph shows the performance of the control system during deposition. The SQC-122 automatically displays the most useful graph for each phase of deposition.

Switch Displays toggles the process data display in the lower portion of the screen between two different process displays.

Sensor Info replaces the graph with a detailed display of sensor information.

Enough preliminaries, let's start the process!

Press **Start** from any of the main screen menus to start deposition. If the first layer Start mode was programmed as Manual, you will need to press the Start Layer SoftKey now to start the layer.

Note: Don't confuse Manual and Auto Start mode with the Manual/Auto SoftKey. Manual Start is a Process setup parameter that tells the SQC-122 to wait for operator intervention before starting a Layer.

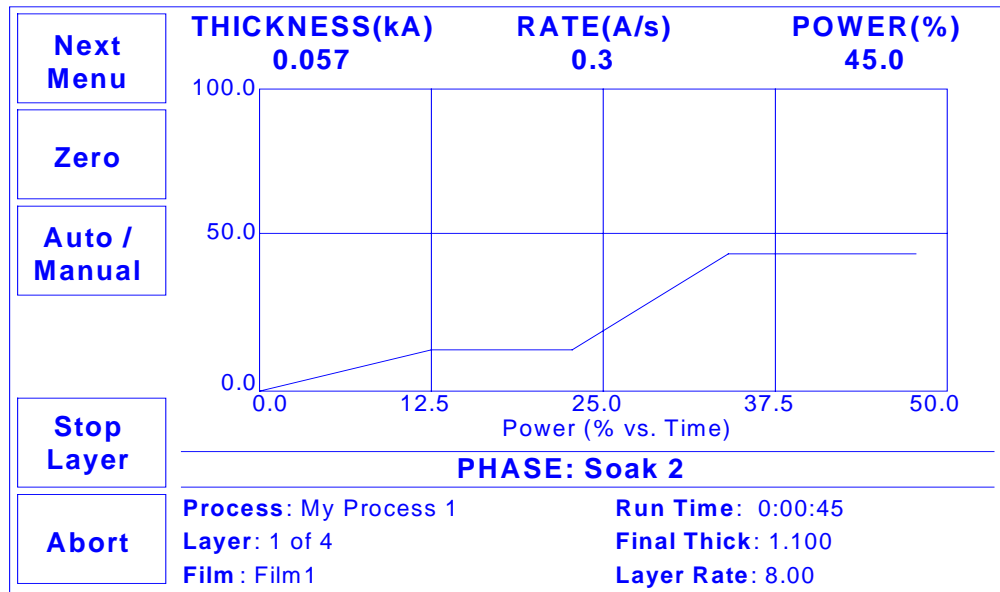

Preconditioning

When Start is pushed, the process starts with the first layer preconditioning phase. When preconditioning is complete, the deposition phase begins. The deposition phase ends when Final Thickness is reached for the layer, then Feed and Idle phases run (if programmed).

If the second layer is Auto Start, its cycle begins immediately when the first layer is complete. If the second Layer is Manual Start, or it's the last layer in the process, the process halts and waits for operator intervention.

While the process is running, a Stop Layer SoftKey is shown (see above). Pressing **Stop Layer** temporarily halts the current layer and displays two restart options, Start Nxt Layer and Restart Layer.

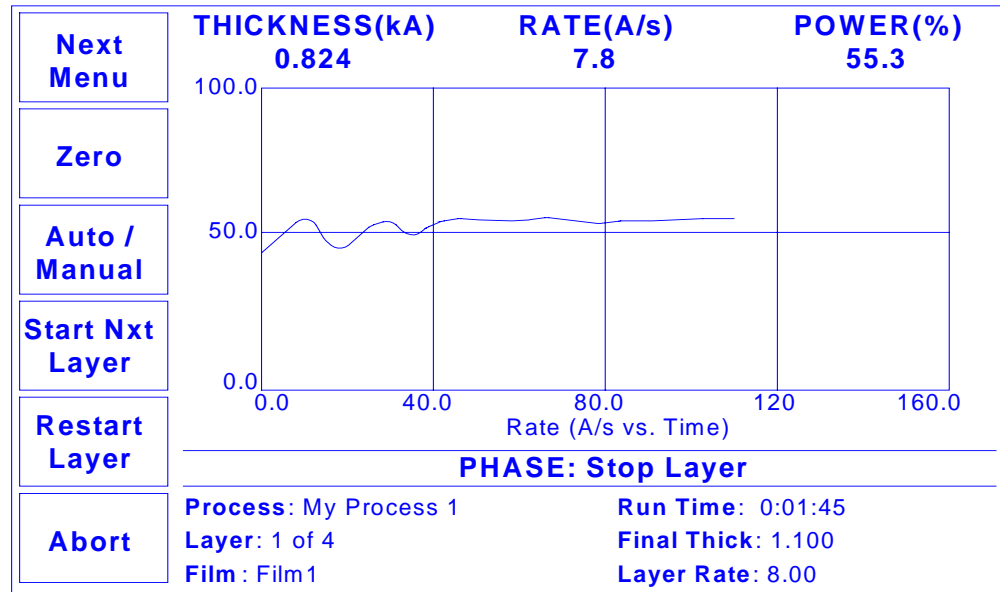

Layer Stopped

Restart Layer repeats the stopped layer, beginning with preconditioning. **Start Nxt Layer** skips the remainder of the current layer and immediately starts the next layer.

Note: Pressing the Abort SoftKey at any time completely aborts the process. You can only restart the process at Layer 1!

Spend some time in Simulate mode verifying that the process sequences through each phase of each layer as expected. If not, use the Quick Setup, Process, and Film menus to make corrections.

Because the process is being “simulated,” some parameters will not be correct for your process (particularly, PID). However, you can become familiar with the effect of each parameter in this simulated process. Also practice using the Next Menu options, especially Auto/Manual modes.

Once you have verified the process in Simulate Mode, you may return to the System Params menu and turn Simulate OFF to start testing your process. Use the next section to finalize the loop PID settings.

2.7 Loop Tuning

This section will help you adjust your control loop PID parameters to achieve a stable deposition process. Keep in mind that there is no “best” way to determine PID parameters, and no one set of settings that are “best.”

Setup System Parameters: Be sure that the output Scale and crystal Min/Max Frequency parameters are accurate for your system. All Tooling parameters are best set to 100% for now. A Period of .25 seconds is also a good starting point. Simulate should be OFF.

Create a One-Layer Test Process: Create a new film with all default values. Create a new process that has the new film as its only layer, and select it as the current process. In the Quick Setup menu set Init Rate to your desired rate and Final Thickness to a large value, say 10X your desired Final Thickness. Select the proper Sensor(s), Output, and Material. Set Max Power to 100% and Slew rate to 100%.

Test the Setup: Press Auto/Manual to start the layer in Manual mode. Slowly turn the control knob to a power of 10%, and verify that your power supply output is about 10% of full scale. Continue to turn the control knob until a Rate(A/s) above 0 is shown. Again, verify that the power supply output agrees with the SQC-122 Power(%) reading. If the readings don't agree, check your wiring and process setup. In particular, verify that the System Parameters output scale agrees with your power supply input specifications.

Determine Open Loop Gain: Slowly adjust the control knob until the Rate(A/s) reading approximately matches your desired rate (Init Rate in the Quick Setup menu). Record the desired rate Power(%) reading as PWR_{DR} . Slowly lower the power until the Rate(A/s) reading is just at (or near) zero. Record the zero rate Power(%) reading as PWR_{0R} .

Determine Open Loop Response Time: Calculate 1/3 of your desired rate ($RATE_{1/3}$), and 2/3 of the desired rate ($RATE_{2/3}$) for this layer. Slowly increase the power until Rate(A/s) matches $RATE_{1/3}$. Get ready to record the loop's response to an input change. Quickly adjust Power(%) to PWR_{DR} . Measure the time for the Rate (A/s) reading to reach $RATE_{2/3}$. You may want to do this several times to get an average response time reading. Displaying the Rate graph will also help. Twice the measured time is the step response time, $TIME_{SR}$. $TIME_{SR}$ is typically .7 to 1.5 seconds for E-Beam evaporation, 5 to 20 seconds for thermal evaporation.

Return the output power to 0%, then press Manual/Auto to return to Auto mode. Follow these steps to set the loop PID parameters:

Set PID Values: In the Quick Setup menu set $P=25$, $I=TIME_{SR}$, $D=0$. Exit the Quick Setup menu. Press Start and observe the Power graph. The power should rise from 0%, and stabilize near PWR_{DR} with little ringing or overshoot. If there is more than

about 10% overshoot, lower the P Term. If the time to reach PWR_{DR} is very slow, increase the P Term. A lower I Term will increase response time, a higher value will eliminate ringing and setpoint deviations. It is unlikely you will need any D Term.

Continue to Start the process and adjust PID until steady-state response is smooth and the step response is reasonably controlled. You don't need to totally eliminate ringing during the step if the steady-state response is smooth, preconditioning will minimize step changes.

Set Preconditioning: The power level you recorded as PWR_{OR} is the power where deposition just begins. That's a good value for Ramp 1 power. PWR_{DR} , or slightly less, is a good value for Ramp 2 Power. This will eliminate a large step change when entering the deposition phase.

Once PID terms are established for a material, they will typically be similar for other materials. Only the P Term and preconditioning power levels may need adjustment.

2.8 Troubleshooting

Most SQC-122 problems are caused by defective crystals or improper film setup, particularly incorrect PID settings for the control loop. Follow the procedures below to identify and correct common problems.

2.8.1 No Readings, or Erratic Readings from Sensors:

Disconnect the deposition source supply. This eliminates the possibility that a noisy source, or poor loop tuning, are causing an unstable PID loop.

Verify that the sensors, oscillator and cabling are connected as shown in Section 1.5. Assure that a good ground connection has been made to the SQC-122 chassis.

Replace the quartz crystal. Crystals sometimes fail unexpectedly, or exhibit erratic frequency shifts before total failure. Depending on the material, crystals may fail well before the typical 5MHz value. If you find that crystals consistently fail early, you may want to set Min Frequency in the System Menu to a value higher than 5 MHz.

In the System Menu, assure that Simulate Mode is OFF, and Frequency Min/Max are set properly for your crystals (typically Freq Min=5.0 MHz, Freq Max=6.0 MHz). Some manufacturer's crystals exceed 6MHz when new. Setting Frequency Max to 6.1 Hz will correct that problem, with no bearing on instrument accuracy.

Press Film Menu, Edit, and assure that the proper sensors are enabled. Press Exit to Main, then Next Menu until the Sensor Info SoftKey shows. Press Sensor Info to show sensor frequency and % Life.

While not depositing, observe the % Life display for each active sensor. The value should be stable, between 20% and 100%.

If the % Life reading is zero or unstable: Recheck the wiring from the sensor to the SQC-122, and verify that the SQC-122 is properly grounded. Also check that the crystal is seated properly in the sensor head.

Swap the sensor to the other SQC-122 input. If both SQM-122 inputs show zero or unstable readings, the problem is almost certainly a wiring or sensor problem.

If the % Life is less than 50%: Replace the crystal and assure that % Life is near 100%, very stable. If % Life is not near 100%, check the Frequency Min/Max limits.

If the problem is not corrected: Referring to Section 1.5, disconnect the 6" M/F BNC cable from the external oscillator module. A 5.5 MHz test crystal and BNC barrel adapter is supplied with each oscillator. Attach the test crystal to the oscillator Sensor connector. The display should read about 5.5 MHz, very stable. If not, contact Sigma Instruments technical support.

When the frequency reading is stable, reconnect the source supply. Start the deposition process in Manual mode with 0% output. The % Life readings should remain stable.

Slowly raise the % Output until a rate reading is displayed above the graph. As material is deposited on the crystal, the % Life reading should remain stable, or drop slowly and consistently. If not, check your source supply for erratic output. Also assure that the sensor is not too close to the source (particularly in sputtering).

2.8.2 Incorrect Rate or Thickness Measurement:

First, complete the procedures in Section 2.8.1 to assure reliable sensor operation.

Set the Xtal Tooling as described in the System Menu section of Chapter 3. Incorrect Xtal Tooling values will cause consistently low or high rate/thickness values for every material.

Once the Xtal Tooling is set, set Film Tooling in the Film Menu to 100 unless you are certain that another value is needed for a specific film.

Verify that the Density and Z-Factor values match those in the Materials Parameters Appendix. If the material is not listed, check a materials handbook. Density has a significant effect on rate/thickness calculations.

Z-Factor corrects for stresses as a crystal is coated. If readings are initially accurate, but deteriorate as crystal life drops below 60-70%, you need to adjust the Z-Factor or replace crystals more frequently. The relationship between Z-Factor and Acoustic Impedance is discussed in the Materials Appendix.

2.8.3 Poor Rate Stability:

First, be sure that a stable rate can be achieved in Manual mode, as explained in Section 2.8.1. Once a stable rate is achieved in Manual mode, follow the Loop Tuning procedures of Section 2.7.

This page left blank for your notes.

3.0 Introduction

SQC-122 operation during deposition is accomplished by pressing one of the six SoftKeys along the left of the display. Five menus provide access to all programmable and operating functions:

Main Menu	<p>The Main Menu is displayed at power up. It provides the SoftKey functions and display information necessary to run a thin film deposition.</p> <p>On the Main Menu, you can view additional sub-menus by repeatedly pressing the Next Menu SoftKey. These sub-menus are discussed in Section 3.2.</p>
Quick Setup Menu	<p>Provides immediate access to the most commonly adjusted parameters for the current process and layer.</p>
Process Menu	<p>A process is a sequence of layers of deposited film(s). Each layer in a process has a specific film, final thickness, and deposition rate(s) associated with it. These are accessed from the Process Menu.</p>
Film Menu	<p>A film is basically a material plus the setup information necessary to deposit that material. Settings on the Film Menu include pre/post conditioning, deposition error controls, and the physical chamber setup for that material.</p>
System Parameters Menu	<p>System parameters control the overall operation of the SQC-122. Tooling, crystal frequency, and operating modes are examples of settings found on the System Parameters Menu.</p>

The remainder of this chapter provides a detailed explanation of each menu and its settings.

3.1 Main Menu

The default, power-up Main Screen display is shown below.

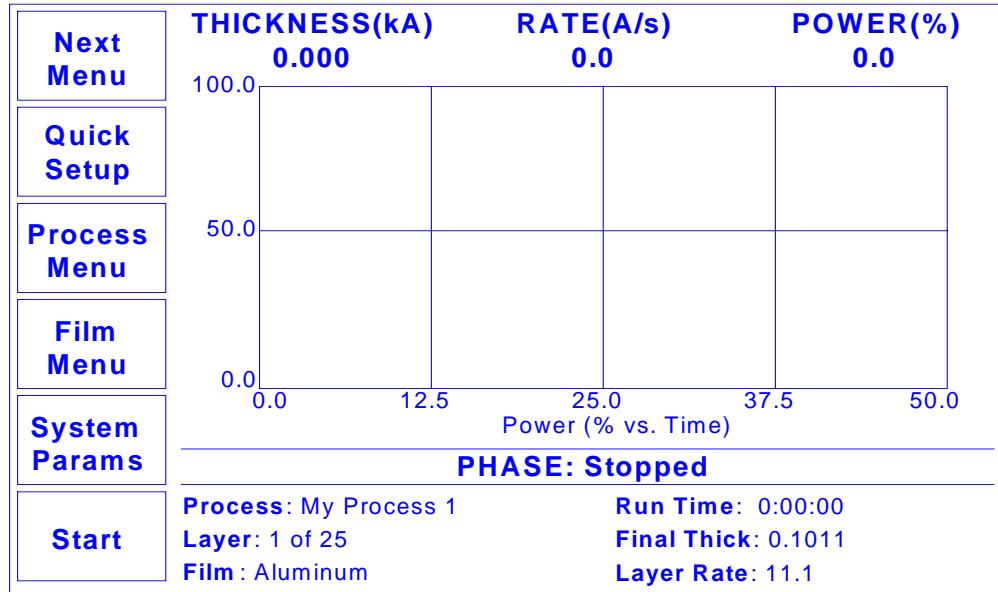

Main Screen

The measured Thickness, Rate, and output Power values are always displayed along the top of the screen.

The graph displays either Rate, Rate Deviation, or output Power. The next section of the manual describes graph selection.

The status bar below the graph displays the current deposition phase. In Manual mode, Manual Power is displayed in the status bar. In Auto mode, the status bar will automatically sequence through the pre-condition, deposit, and feed/idle phases for each layer, as defined by the Process setup.

Below the status bar, important settings for the current process are shown. The next section explains other parameters that can be displayed in this screen area.

The Main Screen SoftKeys undergo subtle changes based on the current process status. The table below describes the function of each of the possible SoftKeys on the Main Screen.

Next Menu	Displays additional Main Menu options as described in Section 3.2.
Quick Setup	Displays the Quick Setup Menu of commonly changed process values.
Process Menu	Create, delete, and edit up to 25 processes. Also used to select the currently active process. When a process is running, this selection is not available.
Film Menu	Create, delete, and edit up to 25 films. A film is basically a material, and may appear in several processes.
System Params	Sets system-wide operating parameters. Also used to “map” the 8 digital inputs and 8 relays to process functions.
Start Layer	Each layer in a process can be defined as auto start or manual start. Auto start layers begin immediately on completion of the previous layer. Manual start layers wait for the operator to press the Start Layer SoftKey.
Restart / StartNxt Layer	During deposition, it may be necessary to halt a layer to correct a problem. These two SoftKeys allow the operator to either restart the current layer or skip to the next layer.
Stop Layer	Temporarily halts deposition. Deposition is restarted with the Restart or Start Nxt keys.
Start/Abort	Starts or aborts sequencing through the current process layers and deposition cycles. Abort sets both outputs to zero, and abandons the current process.

3.2 Next Menu Screens

The Next Menu SoftKey provides access to two sub-menus of the Main Menu that control display and operating mode preferences.

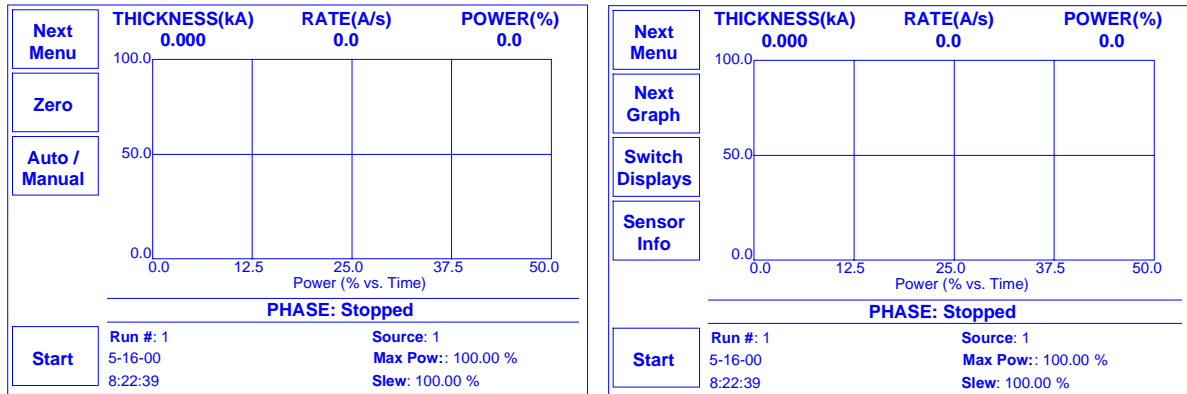

Next Menu Screens

Zero Zeros the thickness reading. Useful for resetting or extending the current deposition layer.

Auto / Manual Toggles between Auto and Manual power control. When Auto/Manual is shown, output power is set by the SQC-122 to achieve the programmed deposition rate. When Manual/Auto is shown, the control knob sets the output power.

Next Graph Cycles through options for the main display. Choose between Rate, Rate Deviation, and Power graphs.

Switch Displays Toggles between data display options at the bottom of the SQC-122 screen. Note the differences between the screens above, and the Main Menu screen in the previous section.

Sensor Info Replaces the graph with the sensor information screen:

Next Menu		THICKNESS(kA)	RATE(A/s)	POWER(%)
		0.000	0.0	0.0
Sensor #	Enable	Frequency	Life	
1	ON	5.543210 MHz	54.32 %	
2	ON	5.654321 MHz	65.43 %	

3.3 Quick Setup Menu

The Quick Setup Menu provides access to the most commonly adjusted parameters for the current process and layer.

Exit to Main	THICKNESS(kA) 0.000	RATE(A/s) 0.0	POWER(%) 0.0
My Process 1 -> Layer 1-> Aluminum			
	Parameter	Value	Units
	Init Rate	11.1	A/s
Edit	Fnl Thk	0.101	kA
	P Term	50	None
	I Term	0.7	Sec.
Prev Layer	D Term	0.0	Sec.
	Sensor 1	On	On/Off
	Sensor 2	On	On/Off
Next Layer	Output	Out1	Out1/Out2
	Max. Power	76.0	%
	Slew Rate	10.0	%
	Material	Aluminum	

Quick Setup Menu

- Exit to Main** Returns to the Main Menu.
- Edit** Selects the highlighted parameter for edit. SoftKey functions change to:
Next: Store parameter and move to next for editing.
Cancel: Stop editing and undo changes to selected parameter.
Enter: Stop editing and save values for selected parameter.
Control Knob: Turn to adjust value. Push to store value and move to next parameter.
- Prev Layer** Displays the parameters for the previous layer in the process.
- Next Layer** Displays the parameters for the next layer in the process.

Quick Setup parameters are described below:

Initial Rate: The beginning rate of deposition for this layer.

Final Thickness: The desired final thickness of this layer. The deposition phase of this layer will end when this thickness is reached.

P Term: Sets the gain of the control loop. High gains yield more responsive (but potentially unstable) loops. Try a value of 50, then gradually increase/decrease the value to respond to step changes in rate setpoint.

I Term: The integral term controls the time constant of the loop response. A small I term, say .5 to 1 seconds, will smooth the response of most loops.

D Term: The differential term causes the loop to respond quickly to changes. Use 0 or a very small value to avoid oscillations.

Sensor 1: Allows quartz crystal Sensor 1 to be turned on or off for the selected layer. If more than one sensor is assigned to a layer, their readings are averaged. If multiple sensors are assigned to a layer, and one fails, it is excluded from measurements.

Sensor 2-6: Allows quartz crystal Sensor 2 to be turned on or off. If the four sensor option card is installed, Sensor 3 to 6 are also visible.

Output: Selects the control voltage output that is active for the selected layer.

Max Power: The maximum output power allowed for the selected output. The Scale output voltage is a function of the deposition power supply input specifications, and is set in the System Parameters menu. Max Power controls the maximum power that can be used by this process layer.

Slew Rate: The maximum power change allowed on an output, per second. If power or rate ramps exceed this value, an error will occur.

Material: Selects a material assigned to this film. As materials change, their density and Z-Factor are updated.

Density: Sets the density for this material. Material density has a significant impact on deposition calculations.

Z-Factor: Sets the Z-factor, an empirically determined measure of a material's effect on quartz crystal frequency change. Z-Factor is the ratio of the acoustic impedance of the sensor to that of the deposited material. It is used to match the acoustic (oscillation) properties of the material to the quartz sensor. If you know the "acoustic impedance" of your material, divide it by 8.83 (the acoustic impedance of SiO₂) to obtain the material's Z-Factor.

3.4 Process Menu

There are several tiers of Process Menu. The first menu (shown below) selects the current process. The current process is the process that is ready to run, and also the process that is selected for editing.

	THICKNESS(kA)	RATE(A/s)	POWER(%)
Main Screen	0.000	0.0	0.0
	My Process 1 -> Layer 1 -> Aluminum		
Prev Menu	Scroll Processes with Knob		
Edit	1. My Process 1		
Delete	2. My Process 2		
	3. My Process 3		
	4. My Process 4		
	5. My Process 5		
	6. My Process 6		
	7. My Process 7		
	8. My Process 8		
	9. My Process 9		
	10. My Process 10		
	11. My Process 11		

Process Select Menu

Main Screen	Returns to the Main Menu.
Prev Menu	Steps back through the sequence of process menus: Process Select <-> Layer Select <-> Layer Edit. On the topmost Process Menu, returns to the Main Menu.
Select / Edit	Select sets the highlighted process as the current process. Edit displays the Layer Select Menu for the current process.
Delete	Deletes the highlighted process and all of its layers.
Control Knob	Scrolls through the list of processes. When pressed, selects or begins editing the highlighted process.

The second Process Menu shows the sequence of layers that will be deposited in the current process.

Main Screen Prev Menu Edit Cut / Paste Insert Layer	THICKNESS(kA) 0.000	RATE(A/s) 0.0	POWER(%) 0.0
	My Process 2 -> Layer 2 -> Aluminum		
	Layer	Film	▲
	Layer 1	Aluminum	
	Layer 2	AluminumOxide	

Layer Select Menu

Main Screen	Returns to the Main Menu.
Prev Menu	Returns to the Process Select Menu.
Edit	Displays the Layer Edit Menu for the highlighted layer (see next page).
Cut / Paste	Used to develop the sequence of layers in a process. The highlighted layer may be Cut (removed from the process) or Copied to the clipboard. The layer on the clipboard can then be Pasted anywhere in the list of layers.
Insert Layer	Shows the list of 25 films. Select a film, then press Enter to insert the film as a new layer.
Control Knob	Scrolls through the list of layers in the Layer Select Menu, and through the list of films in the Insert Layer mode. When pressed, begins editing of the highlighted layer.

Each layer consists of a film (i.e. a material), plus the deposition rate and thickness that are desired for this layer. The Layer Edit Menu provides access to these layer parameters:

Exit to Main	THICKNESS(kA) 0.000	RATE(A/s) 0.0	POWER(%) 0.0
My Process 2 -> Layer 2 -> AluminumOxide			
Prev Menu	Parameter	Value	Units
Edit	Init Rate	9.9	A/s
	Fnl Thk	9.000	kA
	Time Setpoint	0:00:00	h:mm:ss
	Thickness Limit	0.000	A
	Start Mode	Manual	Auto/Man.
	Ramp 1	Enabled	En/Dis
	Start Thkness	4.500	kA
	Ramp Time	0:10:00	h:mm:ss
	New Rate	99.0	A/s
	Ramp 2	Disabled	En/Dis

Edit Layer Menu

- Exit to Main** Returns to the Main Menu.
- Prev Menu** Returns to the Layer Select Menu.
- Edit** Selects the highlighted parameter for edit. SoftKey functions change to:
Next: Store parameter and move to next for editing.
Cancel: Stop editing and undo changes to selected parameter.
Enter: Stop editing and save values for selected parameter.
Control Knob: Turn to adjust value. Push to store value and move to next parameter.
- Control Knob** Scrolls through the list of layer parameters.

A description of each parameter on the Layer Edit Menu follows:

Initial Rate: The beginning rate of deposition for this layer.

Final Thickness: The desired final thickness of this layer. The deposition phase of this layer will end when this thickness is reached.

Time Setpoint: Sets an arbitrary time, after deposition begins, when the time setpoint relay is activated.

Thickness Limit: Sets an arbitrary thickness when the thickness limit relay is activated.

Start Mode: Determines whether a layer begins automatically upon completion of the previous layer. If Manual start is selected, the previous layer ends at its idle power and waits for the user to push the Start button.

Ramp 1: During the deposition of a layer, it may be desirable to change the deposition rate. For example, you may want to deposit slowly at first, then increase the rate once an initial thickness is reached. Enabling rate ramps provides that capability. Once enabled, these parameters are added to the list.

Start Thickness: The deposited thickness at which the new rate will begin.

Ramp Time: Time allowed for the rate to change from initial rate to new rate.

New Rate: The rate of deposition, which is reached at the end of Ramp 1.

Ramp 2: Two rate ramps are available for each layer. The start thickness for Ramp 2 should be greater than the start thickness for Ramp 1.

3.5 Film Menu

Each film has certain characteristics that determine how it should be deposited. The Film Menu allow you to set parameters that regulate the deposition of each film in a certain process.

	THICKNESS(kA) 0.000	RATE(A/s) 0.0	POWER(%) 0.0
Main Screen	My Process 1 Editing:		
Prev Menu	Scroll Films with Knob		
Edit	1. Film 1		
Delete	2. Film 2		
	3. Film 3		
	4. Film 4		
	5. Film 5		
	6. Film 6		
	7. Film 7		
	8. Film 8		
	9. Film 9		
	10. Film 10		
	11. Film 11		

Film Select Menu

Main Screen	Returns to the Main Menu.
Prev Menu	Steps back through the film menus: Film Select <-> Film Edit <-> Film Conds/Deposit Controls. On the topmost Film Menu, returns to the Main Menu.
Edit	Displays the Film Edit Menu for the highlighted film.
Delete	Deletes the highlighted film. (Note: Films cannot be deleted if they are used in any process.)
Control Knob	Scrolls through the list of films. When pressed, begins editing of the highlighted film.

The material to be deposited is the most significant film parameter. However, a film definition also includes the setup parameters shown below:

Exit to Main	THICKNESS(kA)	RATE(A/s)	POWER(%)
	0.000	0.0	0.0
Prev Menu	My Process 1 Editing: Aluminum		
	Parameter	Value	Units
Edit	P Term	50	None
	I Term	0.7	Sec.
Film Conds.	D Term	0.0	Sec.
	Sensor 1	On	On/Off
Deposit Controls	Sensor 2	On	On/Off
	Film Tooling	100	%
	Output	Out1	Out1/Out2
	Pocket	1	
	Max Power	76.0	%
	Slew Rate	10.0	%
	Crystal Quality	Disabled	

Film Edit Menu

- Exit to Main** Returns to the Main Menu.
- Prev Menu** Returns to the Film Select Menu.
- Edit** Selects the highlighted parameter for edit. SoftKey functions change to:
Next: Store parameter and move to next for editing.
Cancel: Stop editing and undo changes to selected parameter.
Enter: Stop editing and save values for selected parameter.
Control Knob: Turn to adjust value. Push to store value and move to next parameter.
- Film Conds.** Displays pre/post conditioning settings (See 2.6).
- Deposit Controls** Displays deposition control settings (See 2.2).
- Control Knob** Scrolls through the list of film parameters.

The Film Conds SoftKey displays these additional film conditioning settings: (Refer to section 2.2 for definitions).

	THICKNESS(kA)	RATE(A/s)	POWER(%)
	0.000	0.0	0.0
My Process 1 Editing: Aluminum			
Exit to Main	Parameter	Value	Units
Prev Menu	Ramp1 Power	50	%
Edit	Ramp1 Time	0.7	h:mm:ss
	Soak1 Time	0.0	h:mm:ss
	Ramp2 Power	On	%
	Ramp2 Time	On	h:mm:ss
	Soak2 Time	Out1	h:mm:ss
	Feed Power	75.0	%
	Ramp Time	10.0	h:mm:ss
	Feed Time	0:00:00	h:mm:ss
	Idle Power	2.90	%
	Ramp Time	0.950	h:mm:ss

Film Conditioning Menu

- Exit to Main** Returns to the Main Menu.
- Prev Menu** Returns to the Film Edit Menu.
- Edit** Selects the highlighted parameter for edit. SoftKey functions change to:
Next: Store parameter and move to next for editing.
Cancel: Stop editing and undo changes to selected parameter.
Enter: Stop editing and save values for selected parameter.
Control Knob: Turn to adjust value. Push to store value and move to next parameter.
- Control Knob** Scrolls through the list of film conditioning parameters.

The Deposit Controls SoftKey displays these additional film settings: (Refer to section 2.2 for deposition control definitions.)

Exit to Main	THICKNESS(kA) 0.000	RATE(A/s) 0.0	POWER(%) 0.0
	Current: Process 1		EDITING: Film 1
Prev Menu	Parameter	Value	Units
	Shutter Delay	0:01:00	h:mm:ss
	Capture	20.0	%
Edit	Control Error	(Ignore, Stop, Hold)	
	Setting	Hold	
	Error	18.0	%
	Rate Sampling	(Cont,Time,Acc based)	
	Setting	Undefined	
	Accuracy Based	0.0	%

Deposition Controls Menu

- Exit to Main** Returns to the Main Menu.
- Prev Menu** Returns to the Film Edit Menu.
- Edit** Selects the highlighted parameter for edit. SoftKey functions change to:
Next: Store parameter and move to next for editing.
Cancel: Stop editing and undo changes to selected parameter.
Enter: Stop editing and save values for selected parameter.
Control Knob: Turn to adjust value. Push to store value and move to next parameter.
- Control Knob** Scrolls through the list of deposition control parameters.

A description of each film parameter follows:

P Term: The proportional term sets the gain of the control loop. High gains yield more responsive (but potentially unstable) loops. Try a value of 50, then gradually increase/decrease the value to respond to step changes in rate setpoint.

I Term: The integral term controls the time constant of the loop response. A small I term, say .5 to 1 seconds, will smooth the response of most loops.

D Term: The differential term causes the loop to respond quickly to changes. Use 0 or a very small value to avoid oscillations.

Sensor 1: Allows quartz crystal Sensor 1 to be used for the selected film. If both sensors are assigned to a film, their readings are averaged. If two sensors are assigned to a film, and one fails, it is excluded from measurements.

Note: *If a relay is assigned to Dual Crystal Shutter in the I/O Setup Menu, Sensor 1 becomes the primary sensor and Sensor 2 a secondary sensor. Sensor 1 is used until a crystal fail condition occurs. When Sensor 1 fails, measurement automatically switches to Sensor 2. Sensor 2 will be used until the process completes or is aborted. The next process run will return to Sensor 1.*

Sensor 2-6: Allows quartz crystal Sensor 2 to be assigned to the film. If the four sensor option card is installed, Sensor 3 to 6 are also visible.

Film Tooling: Compensates for sensor sensitivity to the selected material. Use Xtal Tooling in the System Params menu to compensate for each sensor individually.

Output: Selects the control voltage output that is active for the selected layer.

Pocket Number: Indicates which pocket (0-7) should be used. At the beginning of each layer the SQC-122 will set up to three relays with the BCD value of the pocket to be used for this film. You must assign the Pocket Bit Relays and Pocket Ready input in System Parameters I/O setup (see section 3.7).

Max Power: The maximum output power allowed for the selected output. The Scale output voltage is a function of the deposition power supply input specifications, and is set in the System Parameters menu. Max Power controls the maximum power that can be used by this process layer.

Slew Rate: The maximum power change allowed on an output, per second. If power or rate ramps exceed this value, an error will occur.

Crystal Quality: The maximum allowed rate deviation, from the rolling average of the previous 16 rate readings. Each time the rate deviation exceeds the selected percent value, a counter is incremented. Each time the deviation is within the selected value,

the counter is decremented (to 0 minimum). If the counter reaches 100 during a process, the process is aborted. Crystal Quality settings from 0 to 9 indicate:

0	Disabled	5	12.5%
1	30.0%	6	10.0%
2	25.0%	7	7.5%
3	20.0%	8	5.0%
4	15.0%	9	2.5%

Note: *The Crystal Quality setting is very sensitive to PID loop tuning. It is best to leave Crystal Quality disabled until you are confident of your process and PID settings.*

Crystal Stability: As material is deposited on the crystal, the frequency normally decreases. However arcing, mode hopping, or external stresses may cause the crystal frequency to increase. If the accumulated value of these positive frequency shifts (or a single large positive shift) exceeds a threshold during a process, a crystal fail condition is indicated.

0	Disabled	5	200 Hz
1	5000 Hz (1250 Hz single shift)	6	200 Hz (100Hz single shift)
2	1000 Hz	7	100 Hz
3	500 Hz	8	100 Hz (50Hz single shift)
4	400 Hz	9	25Hz

Xtal Fail Mode: Programs the action when the last sensor assigned to a film fails. Selecting Halt stops the process. When Timed Power is selected, the instrument uses the last valid rate, thickness, and power readings to calculate the time required to reach final thickness. The power is fixed at the last valid reading and deposition continues for the calculated time. Because there are no sensor readings, this is only a rough estimate. The more stable the process, the more accurate the estimate.

Material: Selects a material assigned to this film. As materials change, their density and Z-Factor are updated.

Density: Sets the density for this material. Material density has a significant impact on deposition calculations.

Z-Factor: Sets the Z-Factor, an empirically determined measure of a material's effect on quartz crystal frequency change.

Ramp 1: Ramp power sets the power level desired at the end of the ramp phase, in % of Scale 1,2. Ramp time sets the time to ramp linearly from the initial power to the Ramp power. Soak time sets the time the output remains at the ramp power level.

Ramp 2: Ramp 2 functions are the same as Ramp 1. Typically, Ramp 2 power is set near the power level required to achieve the desired initial deposition rate.

Feed: The feed phase holds output power at the level and time required to wire feed new material.

Idle: Idle power ramps output power back to zero, or holds the material at a state that is ready for deposition (usually the same as Ramp 2 power).

Shutter Delay: It is often desirable to obtain deposition control before the substrate shutter opens. Enabling shutter delay requires that the system reach a specific capture accuracy before the shutter opens. If the capture accuracy is not reached within the shutter delay time, the process halts. Otherwise, the substrate shutter opens and deposition begins when control accuracy has been maintained for 5 seconds. The thickness reading is zeroed at the end of the shutter delay period.

Capture: The control accuracy (%) that must be reached to end the shutter delay.

Control Error: If the control loop cannot maintain the desired deposition rate, due to loss of source material, excess rate ramps, or equipment malfunction, a control error occurs. The error condition can be ignored, the process stopped (output power to 0%), or the output power held at the same level as when the error occurred. If hold is selected, PID control is abandoned, but the process will continue to be monitored for thickness setpoint.

Rate Sampling: Rate sampling can extend the life of crystals. With rate sampling, the deposition rate is sampled for a period of time, then the sensor shutter is closed. Power is then held at the same level as the final power setting during the sample period.

- Continuous selects no sampling, the sensor shutter remains open during deposition.
- Time based sampling opens the shutter for a fixed period of time, then closes it for a fixed time.
- Accuracy based sampling opens and closes the shutter at the rate required to maintain the desired accuracy during the hold phase.

3.6 System Parameters Menu

The System Parameters Menu contains settings that affect the basic operation of the SQC-122. System parameters generally pertain to the physical setup of your vacuum system equipment.

		THICKNESS(kA)	RATE(A/s)	POWER(%)
		0.000	0.0	0.0
My Process 1 -> Layer 1 -> Aluminum				
		Parameter	Value	Units
		Period	.25	Sec
		System Tooling	100	%
		Xtal Tool 1	100	%
		Xtal Tool 2	100	%
		Simulate Mode	Off	On/Off
		Min Frequency	5.0e+06	Hz
		Max Frequency	6.0e+06	Hz
		Scale 1	2.5	Volts
		Scale 2	2.6	Volts
		Contrast	1.5	
		Dev Graph Limit	20.0	%

Edit System Params Menu

- Exit to Main** Returns to the Main Menu.
- Edit** Selects the highlighted parameter for edit. SoftKey functions change to:
Next: Store parameter and move to next for editing.
Cancel: Stop editing and undo changes to selected parameter.
Enter: Stop editing and save values for selected parameter.
Control Knob: Turn to adjust value. Push to store value and move to next parameter.
- I / O Setup** Displays menu for mapping of inputs and outputs.
- Control Knob** Scrolls through the list of system parameters.

Descriptions of each system parameter follows:

Period: Sets the measurement period between .1 second (10 readings per second) and 1 second. A longer period gives higher reading accuracy, especially in low rate applications.

System Tooling: Adjusts for overall sensor deposition rates that differ from the measured substrate deposition rate.

Xtal Tooling 1: Adjusts for sensor deposition rates that differ from the measured substrate deposition rate, because of sensor location. For example, if the sensor sees only 50% of the substrate rate, set the value to 50%.

Xtal Tooling 2-6: Same function as described above. If the four sensor option card is installed, Sensor 3 to 6 are also visible.

Simulate Mode: Normal mode uses the quartz crystals as inputs to the SQC-122 for PID calculations and source output control. Simulate mode simulates the quartz crystals based on the crystal frequencies set on this. Simulate mode is useful for debugging process recipes.

Min/Max Frequency: The frequency values for the quartz crystal sensors used as inputs to the SQC-122. The maximum frequency should be set to the frequency of a new crystal, typically 6MHz. Sensor readings outside the min/max values cause an error.

Scale 1 and Scale 2: The input voltage required by the deposition source power supply to produce 100% output power. Positive or negative Scale 1,2 values are possible.

Contrast: Sets display contrast.

Dev Graph Limit: Sets the upper limit for the Rate Deviation graph Y axis.

Rate Alarm Low: Sets the % deviation below rate setpoint that causes an audible alarm.

Rate Alarm High: Sets the % deviation above rate setpoint that causes an audible alarm. The tone of the high rate alarm is lower than that of the low rate alarm.

Password Enable: If Password is enabled, the Quick Start, Film and System Menus require a password. The Process Menu can be used to select a process, but a password is required to make any changes on the Process Menu.

Password: If password is enabled, this parameter sets the sequence of SoftKeys to press to enter menus. Press the desired sequence to set the password. Holding down the top and bottom switch while powering up the SQC-122 sets the password to "1111."

System Time: Sets the SQC-122 clock to your local time. System time is battery backed up. Does not compensate for daylight savings time.

System Date: Sets the SQC-122 date to your local time. System date is battery backed up.

3.7 I/O Setup

The I / O Setup SoftKey displays a menu allowing you to map the eight digital inputs and the eight digital outputs.

	THICKNESS(kA)	RATE(A/s)	POWER(%)
	0.000	0.0	0.0
My Process 1 -> Layer 1 -> Aluminum			
Exit to Main	Parameter		Value
Prev Menu	Input 1		None
Edit	Input 2		None
	Input 3		None
	Input 4		None
	Input 5		None
	Input 6		None
	Input 7		None
	Input 8		None
	Relay 1		None
	Relay 2		None
	Relay 3		None

I / O Mapping Menu

- Exit to Main** Returns to the Main Menu.
- Prev Menu** Returns to the System Parameters Menu.
- Edit** Selects the highlighted parameter for edit. SoftKey functions change to:
Next: Store parameter and move to next for editing.
Cancel: Stop editing and undo changes to selected parameter.
Enter: Stop editing and save value for selected parameter.
Control Knob: Turn to adjust value. Push to store value and move to next parameter.
- Control Knob** Scrolls through the list of inputs and relays.

In the I/O Setup Menu, any number of “events” can be mapped to the eight digital inputs and eight relay outputs. Options are set by selecting a relay or input and then turning the control knob to select the desired setting. The following explains each event:

Relays

Source 1 Shutter
 Source 2 Shutter
 Sensor 1 Shutter
 Sensor 2 Shutter
 All Crystal Fail
 Sensor 1 Fail
 Sensor 2 Fail
 PreCond Phase
 Deposit Phase
 SoakHold Phase
 Process Active
 Stopped
 Manual Mode
 Max Power
 Time Setpoint
 Thickness Setpoint
 Final Thickness
 Pocket 1-8
 Dual Crystal Shutter
 None

Explanation (closes when)

Deposit phase for films set to Output 1.
 Deposit phase for films set to Output 2.
 Shutter Delay and Deposit phases of films set to Sensor 1.
 Shutter Delay and Deposit phases of films set to Sensor 2.
 All sensors assigned to this film have failed.
 Sensor 1 is assigned to this film, and has failed.
 Sensor 2 is assigned to this film, and has failed.
 Process is in Ramp1, Soak1, Ramp2, or Soak2 phase.
 Process is in Deposit phase.
 Process is in Soak/Hold phase.
 Process is running (not stopped).
 Process is stopped (not running).
 Process is in Manual mode (not under PID control).
 Active output is at maximum power (out of material?).
 The process has been in Deposit phase the indicated time.
 Thickness setpoint reached. Resets on start of next Layer.
 Final thickness reached. Resets on start of next Layer.
 Source pocket select.
 Primary sensor in a dual sensor has failed.
 This relay is not assigned to any event.

Inputs

Abort Process
 Start Process
 Stop Layer
 Restart Layer
 Start Next Layer
 Soak Hold
 Force Final Thickness
 Zero Thickness
 Zero Time
 Start Process 1-25
 Pocket Ready
 None

Explanation (high input causes)

Abort the process. Can only restart at Layer 1.
 Start the process at Layer 1.
 Stop the active layer.
 Start the active layer.
 Start the next layer.
 Delay the start of deposition.
 End deposition.
 Reset thickness reading to zero.
 Reset time setpoint counter to zero.
 Start the selected process.
 The source indexer is on the desired pocket.
 This input is not assigned.

This page left blank for your notes.

4.0 Introduction

The SQC-122 has two slots to accommodate option cards. The Option A slot holds a Four Sensor Card, which expands the SQC-122 to a total of six quartz crystal sensors. The Option B slot is not currently used.

4.1 Option Card Installation

WARNING: Hazardous voltages are present inside the SQC-122 when it is connected to a power source. Remove the power cable before opening the case.

Remove Top Cover	Remove the four screws that attach the top cover to the chassis. Remove the top cover.
Remove Option Cover Plate	Remove the two 4-40 back panel screws that hold the option cover plate. Save the screws. Remove the option cover plate.
Insert Option Card	Insert the option card, <u>from the inside</u> , through the rear panel opening. Align the 36-pin option card connector with the mating pins on the main board, then press the option card connector onto the main board pins.
	<i>Note: If you have difficulty aligning the 36pin header, it may help to temporarily remove the four 6-32 socket screws that attach the rear panel to the side panels.</i>
Secure Option Card	Secure the option card to the rear panel with the screws saved in Step 2. Secure the card to the main board with the supplied 4-40 screw.
Replace Top Cover	Replace the top cover, and attach it to the chassis with the four screws from Step 1.

4.2 Four Sensor Card Configuration

The SQC-122 automatically detects the presence of the Four Sensor Card.

Refer to System Connections in Chapter 1 for sensor hookup information.

Refer to Chapter 2, Sensor Selection, to assign the sensors to a film.

4.3 Full Rack Extender Installation

The Full Rack Extender option (PN 900-007) mounts a single SQC-122 into a full width 19" rack space.

Follow the steps below to assemble the extender and mount the SQC-122:

Remove SQC-122 Mounting Ear	Determine on which side of the SQC-122 you want to attach the rack extender. If a rack mount ear is attached to the SQC-122 on that side, remove the two 10-32 flat head screws that mount the ear, then remove the rack mount ear.
Assemble the Extender	Assemble the extender "box" using the eight 6-32 flat head screws, two end panels, and two main panels. Thread two socket head captive panel screws from the inside of one side of the extender. Continue to thread the captive screws until their threads are completely exposed on one side.
Attach the Extender	Place the extender next to the SQC-122, and thread the captive screws into the SQC-122 threaded holes that were previously used to mount the rack ear. Tighten the captive screws to secure the extender to the SQC-122.
Attach the Mounting Ears	Attach the mounting ear previously removed from the SQC-122 to the extender using the same 10-32 flat head screws. If rack mount ears were not already attached to the SQC-122, attach the other mounting ear also.
Mount the SQC-122	Slide the entire assembly into an empty 5 ¼" high 19" rack mount space. Secure the assembly with four 10-32 rack screws (not supplied).

A. Material Parameters

Material	Density	ZFactor
Aluminum	2.73	1.08
Aluminum Oxide	3.97	1
Antimony	6.62	0.768
Arsenic	5.73	0.966
Barium	3.5	2.1
Beryllium	1.85	0.543
Bismuth	9.8	0.79
Bismuth Oxide	8.9	1
Boron	2.54	0.389
Cadmium	8.64	0.682
Cadmium Selenium	5.81	1
Cadmium Sulfide	4.83	1.02
Cadmium Teluridium	5.85	0.98
Calcium	1.55	2.62
Calcium Fluoride	3.18	0.775

Material	Density	ZFactor
Manganese	7.2	0.377
Manganese Sulfide	3.99	0.94
Mercury	13.46	0.74
Molybdenum	10.2	0.257
Neodymium Fluoride	6.506	1
Neodymium Oxide	7.24	1
New	1	1
Nickel	8.91	0.331
Niobium	8.57	0.493
Niobium Oxide	4.47	1
Palladium	12	0.357
Platinum	21.4	0.245
Potassium Chloride	1.98	2.05
Rhenium	21.04	0.15
Rhodium	12.41	0.21

Carbon Diamond	3.52	0.22	Samarium	7.54	0.89
Carbon Graphite	2.25	3.26	Scandium	3	0.91
Cerium Fluoride	6.16	1	Selenium	4.82	0.864
Cerium Oxide	7.13	1	Silicon	2.32	0.712
Chromium	7.2	0.305	Silicon Dioxide	2.2	1.07
Chromium Oxide	5.21	1	Silicon Oxide	2.13	0.87
Cobalt	8.71	0.343	Silver	10.5	0.529
Copper	8.93	0.437	Silver Bromide	6.47	1.18
Copper Sulfide	4.6	0.82	Silver Chloride	5.56	1.32
Copper Sulfide B	5.8	0.67	Sodium	0.97	4.8
Copper Sulfide A	5.6	0.69	Sodium Chloride	2.17	1.57
Dysprosium	8.54	0.6	Sulfur	2.07	2.29
Erbium	9.05	0.74	Tantalum	16.6	0.262
Gadolinium	7.89	0.67	Tantalum Oxide	8.2	0.3
Gallium	5.93	0.593	Tellurium	6.25	0.9
Gallium Arsenide	5.31	1.59	Terbium	8.27	0.66
Germanium	5.35	0.516	Thallium	11.85	1.55
Gold	19.3	.381	Thorium Fluoride	6.32	1
Hafnium	13.1	0.36	Tin	7.3	0.724
Hafnium Oxide	9.63	1	Titanium	4.5	0.628
Holmium	8.8	0.58	Titanium Oxide	4.9	1
Indium	7.3	0.841	Titanium Oxide IV	4.26	0.4
Indium Intimnide	5.76	0.769	Tungsten	19.3	0.163
Indium Oxide	7.18	1	Tungsten Carbide	15.6	0.151
Iridium	22.4	0.129	Uranium	18.7	0.238
Iron	7.86	0.349	Vanadium	5.96	0.53
Lanthanum	6.17	0.92	Ytterbium	6.98	1.13
Lanthanum Fluoride	5.94	1	Yttrium	4.34	0.835
Lanthanum Oxide	6.51	1	Yttrium Oxide	5.01	1
Lead	11.3	1.13	Zinc	7.04	0.514
Lead Sulfide	7.5	0.566	Zinc Oxide	5.61	0.556
Lithium	0.53	5.9	Zinc Selenide	5.26	0.722
Lithium Fluoride	2.64	0.774	Zinc Sulfide	4.09	0.775
Magnesium	1.74	1.61	Zirconium Oxide	5.6	1.001
Magnesium Fluoride	3	1			

B. Specifications

Measurement

Number of Sensors	2
Frequency Range	4.0MHz to 6.0Mhz
Frequency Accuracy	.01% @ 2 rdgs/sec.
Frequency Resolution	.1 Hz
Rate Accuracy	.5% typical
Rate Resolution	.01/.1 Å/s
Thickness Accuracy	.5% typical
Thickness Resolution	1 Å
Measurement Period	.1 to 1 sec.

Source

Number of Sources	2
Control Voltage	0 to $\pm 10V$ into $2k\Omega$ load
Resolution	15 bits

Digital I/O

Digital Inputs	8
Functions	Shutter, Thickness Setpoint, Time Setpoint, All Crystal Fail
Input Rating	5VDC, non-isolated
Relay Outputs	8
Functions	Source Shutter, Close Shutter, Zero Thickness, Zero Time
Relay Rating	30Vrms or 30VDC, 2A maximum

General Specifications

Mains Power Supply	100-120/200-240~, $\pm 10\%$ nominal 50/60HZ
Power Consumption	25W
Operating & Transportation Environment	0°C to 50°C 0 to 80% RH non-condensing 0 to 2,000 meters Indoor Use Only Class 1 Equipment (Grounded Type) Suitable for Continuous Operation Ordinary Protection (not protected against harmful ingress of moisture) Pollution Degree II Installation (Overvoltage) Category II for transient overvoltages
Storage Environment	-40°C to 70°C
Rack Dimensions (HxWxD)	88.5mm x 212.7mm x 196.9mm
Weight	13.2 kg (6 lbs)

Display

Graphs	Rate, Deviation, Power
Readouts	Thickness, Rate, Power

Process Parameters (a Process is a sequence of layers)

# Processes	25
# Films	25
# Layers (total all processes)	250

Layer Parameters (Layer is a Film, plus these values)

Initial Rate	0.0 to 999.9 Å/sec.
Final Thickness	0.0 to 999.9 Å
Time Setpoint	0 to 30000 sec.
Thickness Limit	0.0 to 999.9 Å
Start Mode	Auto/Manual

# Rate Ramps	2
Rate Ramp Start	0.0 to 999.9 Å
Rate Ramp Time	0 to 1000 sec.
New Rate	0.0 to 999.9 Å/sec
Film Parameters (Film is a Material, plus these values)	
Material	100 stored
Density	0.40 to 99.99 gm/cm ³
Z Factor	0.100 to 9.900
P Term	1 to 9999
I Term	0 to 99.9 sec.
D Term	0 to 99.9 sec.
Sensor (1,2)	On/Off
Output	1 or 2
Max Power	0.0 to 100.0 %
Slew Rate	0.0 to 100.0 %/sec.
Ramp Time (1,2)	0 to 30000 sec.
Soak Power (1,2)	0.0 to 100.0 %
Soak Time (1,2)	0 to 30000 sec.
Feed Ramp Time	0 to 30000 sec.
Feed Power	0.0 to 100.0 %
Feed Time	0 to 30000 sec.
Idle Ramp Time	0 to 30000 sec.
Idle Power	0.0 to 100.0 %
Shutter Delay Time	0 to 200 sec.
Shutter Delay Error	0.0 to 30.0 %
Control Error	Ignore/Stop/Hold
Control Error Setting	0 to 30.0 %
Rate Sampling	Continuous/Time/Accuracy
Sample Time	10.0 to 999.0 sec.
Hold Time	10.0 to 999.0 sec.

C. I/O Connections

Two 15-pin D-sub connectors, located on the rear of the SQC-122, provide Input/Output connections.

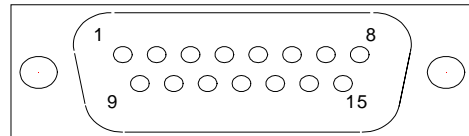

Relay I/O Connectors

Inputs can be activated either by connecting to a switch and shorting to Ground, or they can be driven by a TTL compatible signal.

WARNING: These are not isolated inputs! The voltage level applied must be limited to between 0 and +5 volts with respect to Ground.

WARNING: Output relays are rated for 30Vrms or 30VDC, at 2A maximum. Proper fusing, and adequate wiring insulation and separation, should be provided to assure these limits are not exceeded.

Relay I/O 1-4

Pins	Connection
1,2	Relay 1
3,4	Relay 2
5,6	Relay 3
7,8	Relay 4
9	Input 1
10	Input 2
11	Input 3
12	Input 4
13,14,15	Ground

Relay I/O 5-8

Pins	Connection
1,2	Relay 5
3,4	Relay 6
5,6	Relay 7
7,8	Relay 8
9	Input 5
10	Input 6
11	Input 7
12	Input 8
13,14,15	Ground

Refer to Sections 3.6 for relay and input definitions.

D. Handheld Remote Controller

The Handheld Controller provides the capability of adjusting output power remotely when the SQC-122 is in Manual Mode.

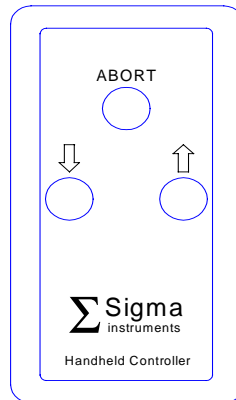

To use the handheld controller, attach the cable from the handheld controller to the Remote jack on the SQC-122 front panel. Select a Process using the SQC-122 front panel SoftKeys. Press Next Menu until the Auto/Manual SoftKey is displayed. Press Auto/Manual to change to Manual power mode (SoftKey shows Manual/Auto). Press Start to begin the film deposition.

You can now use either the front panel Control Knob or the Handheld Controller to adjust output power. Pressing Abort on the handheld controller stops the film and returns output power to 0%.

E. EC Declaration of Conformity

Manufacturer's Name: Sigma Instruments

Manufacturer's Address: 1318 Duff Drive

Fort Collins, CO 80524 USA

declares that the product:

Product Name: Deposition Rate Controller

Product Model: SQC-122

Product Options: All Options

conforms to the following Directives:

73/23/EEC (93/68/EEC)
89/336/EEC

Low Voltage Directive
Electromagnetic Compatibility Directive

uses the following standards:

EN 61010-1	Safety of Electrical Equipment for Measurement, Control, and Laboratory Use
EN 50081-2	Generic Standard for Emissions
EN 55011	Radiated and Conducted Emissions (Class A)
EN 50082-2	Generic Standard for Immunity
EN 61000-4-2	Electrostatic Discharge
EN 61000-4-3	Radiated RF Electro-Magnetic Field
EN 61000-4-4	Electrical Fast Transient/Burst
EN 61000-4-6	Conducted RF
ENV 50204	Radiated RF

And complies with the Essential Health and Safety Requirements.

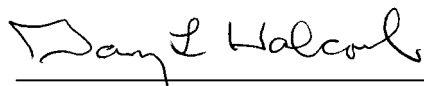

Gary L. Halcomb
President
